

FIRAT

P R O D U C T

C A T A L O G U E



CONTENTS

FIRAT	02 - 05
NEW PRODUCTS	06 - 07
PEX-AL-PEX PIPES	08 - 11
PERT-AL-PERT PIPES & PRESS FITTINGS	12 - 17
PE-X PIPES AND FITTINGS	18 - 21
IZOPEX / PRE-INSULATED MULTILAYER PIPES	22 - 27
METAL SYSTEMS	28 - 35
PPRC PIPES AND FITTINGS	36 - 51
DUBLEX PIPES AND FITTINGS	52 - 60
GEDIZ PIPES	61
RESIDENCE SILENT PIPES AND FITTINGS	62 - 71
RAIN GUTTERS AND FITTINGS	72 - 77
PE PIPES	78 - 79
HOSES & DRAINAGE PIPES	80 - 86
OUR QUALITY CERTIFICATES & EXPORT MAP	87 - 88

FIRAT



Founded in 1972 with the principles of high quality, product variety, and customer satisfaction, Firat Plastik Kauçuk Sanayi A.Ş. is the leading company in its sector in the field of construction plastics. Delivering innovative products across the globe, Firat proudly represents Türkiye on five continents and in over 100 countries, holding a prominent position in exports.

With its broad product range and high production capacity, Firat serves as a solution partner to various industries—including construction, agriculture, automotive, medical, and home appliances. The company manufactures its products using advanced technology at two major facilities located in Büyükçekmece (Istanbul) and Sincan (Ankara), spanning a total of 445,000 square meters. These facilities rank among the world's few integrated plastic production complexes.

Firat offers over 10,000 product types. To ensure maximum customer benefit and satisfaction, Firat products are designed and manufactured as integrated systems that complement one another.



Our Main Product Groups Include:

Superstructure Systems: PPRC Composite Pipes and Fittings, PVC Dublex and Residence Silent Wastewater Pipes and Fittings, Triplex Wastewater Pipes and Fittings, PVC Rain Gutters and Fittings, PVC Hose Groups, Rubber and PE-Based Hoses, PVC Drainage Pipes, PEX Mobile Systems & Underfloor Heating Pipes and Metal Fittings, PERT Pipes and Fittings, PE 32 Pipes, Pex-Al-Pex Multilayer Pipes and Fittings, Insulated Pex-Al-Pex and Pert-Al-Pert Pipes, Pert-Al-Pert Pipes and Fittings, PVC Curtain Rails

Infrastructure Systems: HDPE Pipes and Fittings, Triplex Wastewater Pipes and Fittings, Triplex Perforated Drainage Pipes, PP & PE Sheets, LDPE Pipes and Fittings, EF Fittings, Manholes and Inspection Chambers, PE Fittings, PE 80 Natural Gas Pipes, PE Drainage Pipes, FKS Sewage Pipes, PVC Tunnel-Type Drainage Pipes and Fittings, Double-Walled Cable Protection Pipes, Dual and Triple PE Manifold Pipes.

PVC Window Systems: PVC Window and Door Profiles, EPDM & TPE Seals, Reinforcement Steel, Metal Injection Accessories (hinges, handles, and window components)

Agricultural Irrigation Systems: Sprinkler Pipes and Fittings, Drip Irrigation Pipes and Fittings

Infrastructure Systems: HDPE Pipes and Fittings, Triplex Wastewater Pipes and Fittings, Triplex Perforated Drainage Pipes, PP & PE Sheets, LDPE Pipes and Fittings, EF Fittings, Manholes and Inspection Chambers, PE Fittings, PE 80 Natural Gas Pipes, PE Drainage Pipes, FKS Sewage Pipes, PVC Tunnel-Type Drainage Pipes and Fittings, Double-Walled Cable Protection Pipes, Dual and Triple PE Manifold Pipes

Agricultural Irrigation Systems: Sprinkler Pipes and Fittings, Drip Irrigation Pipes and Fittings.

Medical Products and Vacuum Blood Collection Tubes

Thousands of Firat products are trusted and used across Türkiye and many regions of the world.

Firat Plastik A.Ş. is the only company in the global plastics industry that produces all components (except glass and screws) used in PVC Window and Door Systems under one roof. This enables 100% compatibility between all system elements, as the complete production—PVC profiles, EPDM gaskets, TPE gaskets, reinforcement steel, and metal accessories—is carried out within Firat's integrated facilities.

All quality control tests are conducted at FUDEL Laboratory, accredited by TURKAK under ISO 17025 and recognized as the most comprehensive testing facility in the sector. Firat products are delivered to customers with the "Firat Quality Assurance Approval." The company holds a wide range of internationally recognized certifications, including GOST, SKZ, AENOR, CSTB, TÜV AUSTRIA, DVGW, and TSE, as well as full compliance with management system standards such as ISO 9001, ISO 14001, ISO 45001, ISO 27001, ISO 10002, and ISO 50001.

Firat's vision is to use all its resources to achieve continuous customer satisfaction, drive growth and innovation, and strive for perfection through advanced technologies. The trust in our products—due to their reliability, durability, accessibility, ease of application, and strong after-sales support—is a natural result of our unwavering commitment to excellence.

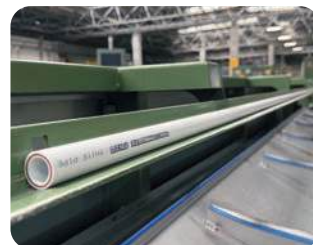



FIRAT Headquarter

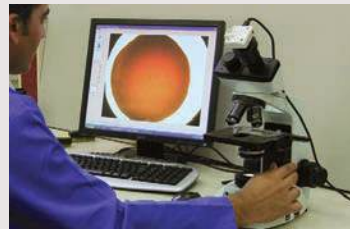

Thousands of FIRAT products, such as PVC window and door profiles, PVC rain gutters, PVC drainage pipes, PVC and PE Hoses, seals and PE hoses, PPRC pipes and fittings, HDPE pipes and fittings, PP&PE sheets, LDPE pipes and fittings, PE fittings, PE 80 natural gas pipes, PVC and PE drainage pipes, FKS sewage systems, FCS pipe systems, PVC tunnel typed drainage pipes, double-walled cable protection pipes, EPDM Seals, TPE Seals, metal injection products (hinges and window fittings), PEX- PERT pipes and fittings, PEX-AL-PEX and PERT AL PERT pipes, Sprinkler and Drip Irrigation pipes are at the service of customers in Turkey and many other points in the world.

Exempting glass and screws, Firat is the only company that manufactures all parts constituting PVC window and door systems in the world plastics sector. Since 100% compatibility between the components of PVC window and door frame systems can only be achieved by producing all of these under the same roof, all PVC profiles, EPDM Seals, TPE Seals, reinforcement plates and metal accessories are manufactured and integrated by F rat in its own facility.

FIRAT PLASTİK KAUÇUK SAN. VE TİC. A.Ş. provides services for the PVC window sector with the brands Firatpen, Winhouse and Gedizpen, as well as the product series Selenit 75, Eelegance 80, Garnet 70, Zenia Slide, and Redonit 85.

After all the quality control tests are completed, Firat products are offered to the market with Firat Quality Assurance Confirmation. Firat is the only company in the sector which holds international quality certificates such as GOST, SKZ, BDS, EMI, DVGW, TSE as well as ISO / IEC 17025 accreditation and all of the system certificates, which are ISO 14001, ISO 45001, ISO 10002, ISO 9001 and ISO 27001. As an environmentally friendly manufacturer, Firat holds an ISO 14000 Environment Management System Certificate.

Firat has achieved customer satisfaction in over 100 countries with its products and has taken a significant, well-deserved position in the sector. Maintaining continuous growth and development, utilizing all resources and striving to achieve perfection through advanced technology are the objectives Firat has adopted. The popularity of our products arises from reliability, durability, ease of access, practicality and after-sales support which result from Firat's endeavor for perfection and excellence.



FIRAT owns Turkey's first and only TÜRKAK accredited quality, control and test laboratory.



New Products

NEW PRODUCT

RESIDENCE SILENT PIPES AND FITTINGS

Residence Power Silent Pipe



Elbow (45°)



Elbow (87°)



T - Piece



Single Branch (45°)



NEW PRODUCT

IZOPEX/PRE-INSULATED MULTILAYER PIPES

Izopex Blue Pipes (Straight)



Izopex Blue Pipes (Serrated)



Izopex Red Pipes (Straight)



Izopex Red Pipes (Serrated)



NEW PRODUCT

PRESS FITTINGS (FOR MULTILAYER PIPES)

Elbow



Double Reduced Nipple



Reduced Te



Nipple With Flat-Faced Connection



NEW PRODUCT

PPRC FITTINGS

Radiator Valve (Straight)



Ball Valve (Metal Handle & Long Type)



Radiator Valve (Angled)



Elbow With Loose Nut



Armature Connector For Bidet



Reducing Corner T - Piece



Short Bridge



Transition Nipple (Female)



New Products

NEW PRODUCT PPRC PN20 PIPES

PPRC Composite Pipes
(Fiber Glass Reinforced)



PPRC Pipes



NEW PRODUCT RED-ORANGE PE-X_b & PERT PIPES IN COVER

Red Pe-X_b & Pert Pipes



Orange Pe-X_b & Pert Pipes



1" Manifold With Ball Valve
(Red-Blue / Outlets:1/2" / Dn25)



1" Manifold
(Red-Blue / Outlets:1/2")

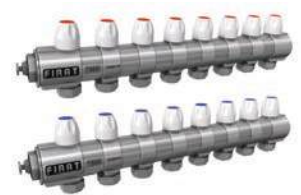

NEW PRODUCT METAL FITTINGS

Ball Valves
For Potable Water
(Pn10)



Gas Ball Valve
For Gas Systems



Gas Ball Valve
For Gas Systems
(Locked)



Ball Valves
For Industrial Purposes
(Pn25)



1/2" Radiator Valve
(Angled)
(New Type)



1/2" Radiator Valve
(Angled)
(Pex Pipe Connection)



Pex-Al-Pex Pipes (Multi Layer Tig Pipes)

TIG Pipes are used for warm and cold water systems, radiator systems, pressured air installations, transmission of cooled fluids, inner-building fresh water systems and floor heating systems. TIG Pipes are produced through a special technology combining the superior features of plastic and metal materials. While the inner and outer layers of TIG Pipes are made of polyethylene, aluminum is used for the production of the middle layer.

The name of this special pipe is derived from the special method used to produce it. Aluminum layer is twisted over the polyethylene layer (its molecule structure includes cross linked PE-Xb) and these two materials are then fixed with arc welding (Tungsten Inert Gas).

Inner and outer surfaces of TIG Pipes are formed by PE-Xb layers which are resistant to high temperatures, hygienic, resistant to corrosion and impacts taking root of external influences, very smooth and which are preventing sedimentation, providing excellent isolation.

In addition to these, a special adhesive and method is used for fixing the inner and outer PE-Xb layers with excellent properties to the aluminum layer.

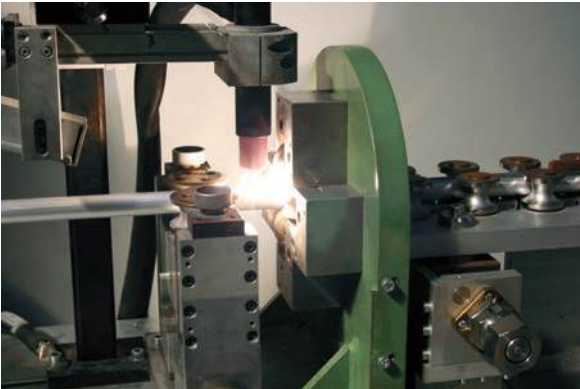

Welding Technology Used for the Aluminum Layer of Tig Pipes

The welding technique named as Tungsten Inert Gas has been considered to be a very important technological development by the plastics industry in recent years. This method includes bending the aluminum layer onto the PE-Xb inner layer and then fixing these two layers through arc butt welding. This technology surpasses the old technologies like overlapping in terms of life time and reliability.



Pex-Al-Pex Pipes (Multi Layer Tig Pipes)

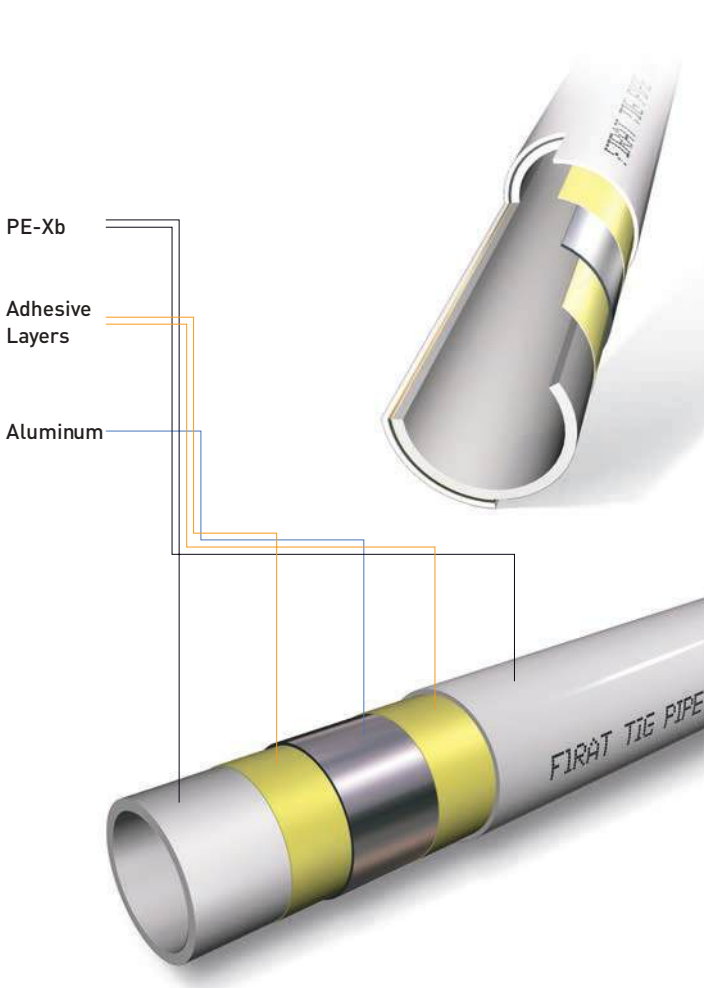

PE-Xb: Polyethylene surface with high resistance.

Aluminum: Aluminum surface entirely covering the inner PE-Xb surface.

Adhesive Layers: High strength bindingsurfaces for binding aluminum and PE-Xb surfaces.

Advantages Provided by PE-Xb Layers

- The outer layer made of PE-Xb prevents corrosion on construction materials (lime, mortar etc.) and the aluminum layer of the pipe. It also provides resistance against impacts.
- The smooth surface of the PE-Xb inner layer both decreases the pressure value and also prevents sedimentation.
- Thermal conduction property of PE-Xb is excellent. Thanks to this, energy saving is possible for hot-water applications.
- The cross-linking PE-Xb forming the inner layer fulfills the human-health requirements for liquid foodstuff and fresh water applications.
- TIG Pipes produced from PE-Xb raw material are ideal for conveying acidic and alkaline fluids thanks to the properties of the raw material.

Specifications for PE-Xb

Density	0,950 gr/cm ³
Water temperature (application)	+95 °C
Softening temperature	135 °C
Thermal conductivit	0,37 kcal/m h °C
Cross-linking degree (minimum)	65 %
Elongation at break	500-600 %
Breaking strength (at 20 °C)	290-300 kg/cm ²



Pex-Al-Pex Pipes (Multi Layer Tig Pipes)

The Relation between Tig Pipes and Oxygen

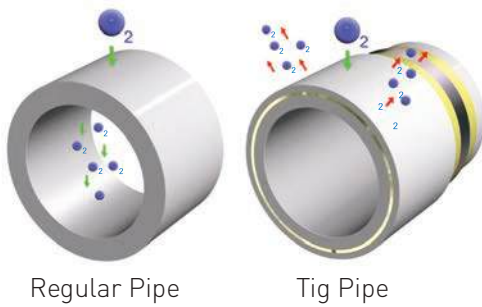

Properties of Cross-Linking Polyethylene (PE-Xb)

Currently, pipes produced from HDPE raw material are used for conveying fluids with maximum temperature of 50°C. However, even at 50°C, it is a must to exercise a pressure lowering factor. On the other hand, pipes made of cross-linking polyethylene (PE-Xb) present an excellent capacity to convey hot water with temperature values higher than 50°C. Service life problem for pipes, related to hot water conveying, is eliminated with the use of cross-linking PE-Xb.

Cross-linking process forms polymer chains between micro-molecules. This process, conducted with Silan method (PE-Xb), delivers a much longer service life for pipes.

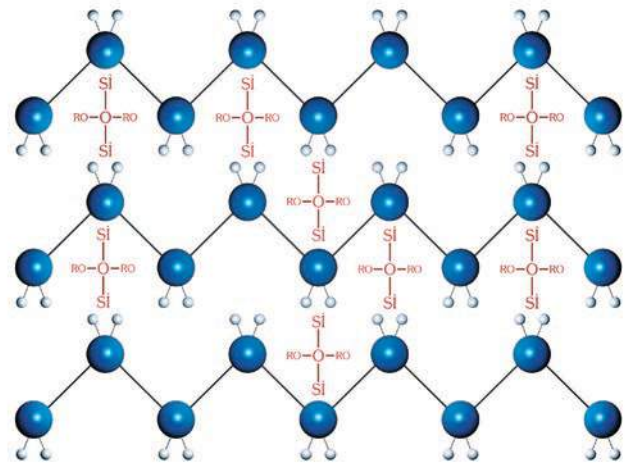

PE-Xb with cross-linking

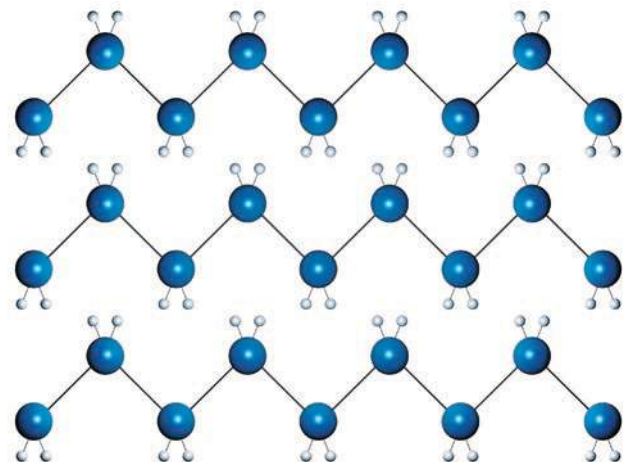

PE without cross-linking

Pex-Al-Pex Pipes (Multi Layer Tig Pipes)

PE-Xb -AL-PE-X b PIPES

CODE	ØD(mm)	d(mm)	t(mm)	L(coil/m)
7495000014	14	14	2	100
7495000017	16	16	2	100
7495000018	16*	16	2*	200
7495000015	16*	16	2*	100
7495000016	16*	16	2*	300
7495000019	18	18	2	100
7495000020	20	16	2	100
7495000021	20*	20	2*	100
7495000025	25	20	2.5	50
7495000026	26*	25	3*	50
7495000027	25*	26	5*	50
7495000032	32*	32	3*	50

*Without carton box package

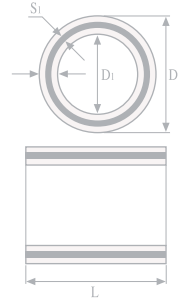

PE-Xb -AL-PE-X b PIPES IN COVER

CODE	ØD(mm)	d(mm)	t(mm)	L(coil/m)
7490004016K Red	16	16	2	50
7490004016M Blue	16	16	2	50
7490004020K Red	20	20	2	50
7490004020M Blue	20	20	2	50

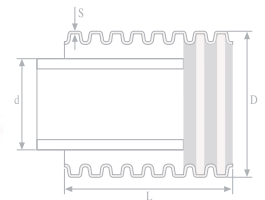

Pex-Al-Pex Pipes (Multi Layer Tig Pipes)

FIRAT multilayer PERT-AL-PERT pipes are used for hot and cold water applications and underground heating systems. Multilayer composite pipe is flexible, can be easily shaped by hand, and maintain its form. This is why pipes are suitable to apply different ground, pavement and wall type systems with varieties of plumbing.

FIRAT PERT-AL-PERT pipes are produced according to German Standard SKZ HR 3.12 (Application Class 4)

Max Operating Temperature: **95°C**

Max Operating Pressure: **10 bar**

Min Bending Radius: **5 x Outer Diameter**

Thermal Conductivity: **0,45 W/m K**

Thermal Expansion Coefficient: **0,026 mm/m K**

PERT-AL-PERT (Five Layered Composite Pipes)

- Long Service Life
- Low thermal conductivity
- High temperature and corrosion resistance
- Hygienic and Environmental Friendly

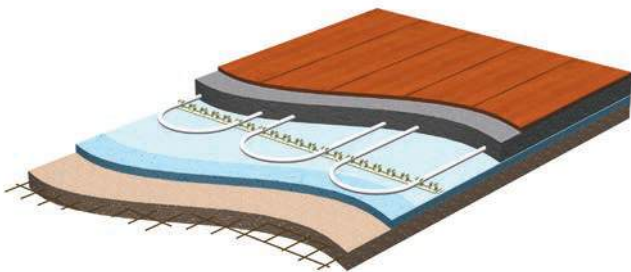

Inner Layer: Smooth and Clear PERT Surface provides great water flow and have all properties and advantages the of PERT.

Adhesive Layer: This special and highly adhesion layer keeps layers together as one in tough conditions.

Aluminum Layer: Integrated to inner layer with adhesive and maintains maximum oxygen impermeability to protect metal components from corrosion.

Adhesive Layer: This special and highly adhesion layer keeps layers together as one even in tough conditions.

Outer Layer: Have all the properties and advantages of PE-RT ro metarial Protects Aluminum core from outside effects and helps to stand against high temperatures.

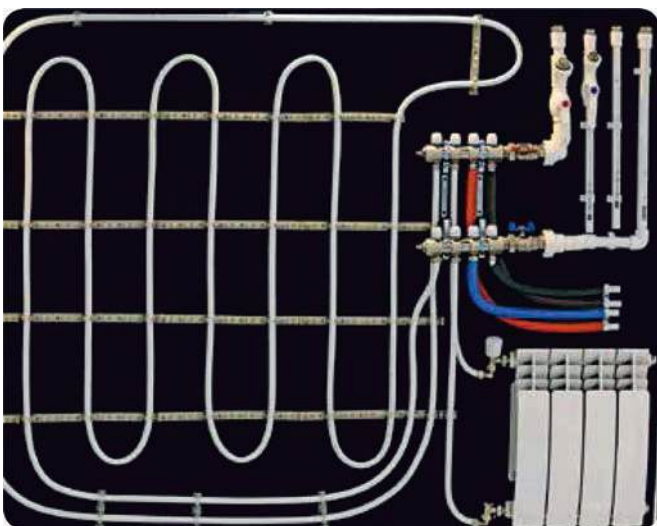

PERT-AL-PERT Pipe has special welding technique named as Tungsten Inert Gas this has been considered to be a very important technological development by the plastics industry in recent years. This method includes bending the aluminum layer onto the PE-RT inner layer and then fixing these two layers through arc butt welding.

Pex-Al-Pex Pipes (Multi Layer Tig Pipes)

Raw Material

PE-RT: Polyethylene of Raised Temperature Resistance
 PE-RT has a higher; Long-Term Hydrostatic strength (LTHS) and Mechanical properties in hot water applications.

Physical Properties	Test Method	Unit	S.I.
Melt Index	ISO 1133	g/10 min.	0,55
Melt Index	ISO 1133	g/10 min.	1,85
Density	ISO 1183	g/cm ³	0,941
Vicat Softening Point	ISO 306	°C	124,7
Thermal Conductivity	DIN 52612-1	W/(mK)	0,4
Thermal Expansion Coefficient	DIN 53752 A	10 ⁻⁴ /K	1,8

Mechanical Properties	Test Method	Unit	S.I.
Hardness, Shore D	ISO 868	-	60,5
Tensile Yield	ISO 527-2	Mpa	20,3
Tensile Yield Elongation	ISO 527-2	%	14
Ultimate Tensile	ISO 527-2	Mpa	37
Ultimate Elongation	ISO 527-2	%	780
Flexural Modulus	ISO 178	Mpa	660
Elastic Modulus (1)	ISO 527-2	Mpa	645
Izod Impact	DIN 180	kJ/m ²	23,0

PERT-AL-PERT PIPES

CODE	ØD (mm)
7496001014	14 x2
7496001016	16 x2
7496001018	18 x2
7496001020	20 x2
7496001025	25 x2.5
7496001026	26 x3
7496001032	32 x3

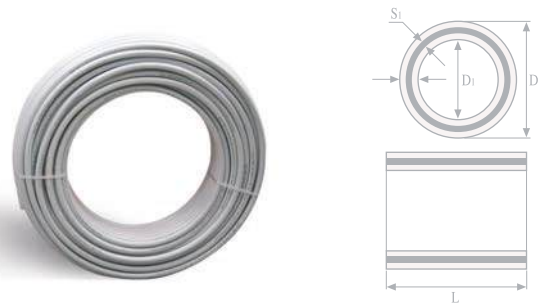

PERT-AL-PERT PIPES IN COVER

CODE	Color	ØD (mm)
7496004016K	Red	16 x2
7496004016M	Blue	16 x2
7496004020K	Red	20 x2
7496004020M	Blue	20 x2

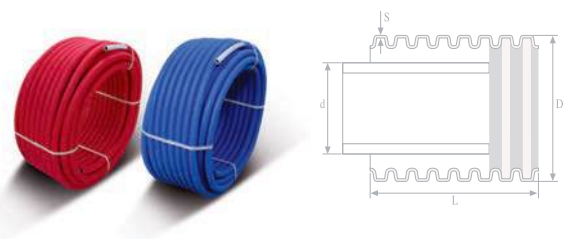

Press Fittings (For Multilayer Pipes)



Tig Pipe Press Fittings are suitable for:

- Hot and cold water supply systems,
- Heating systems,
- Industrial applications

Press Fittings can be used with Pex-Al-Pex and Pert-Al - Pert pipes.



1. Products should be stored in its original packaging which is protected against dust which may come from outside during storage, transportation and installation. Press fitting should not be kept in dusty and corrosive environment.
2. Connection system; The fitting consist of a Plastic Ring, Sleeve and O-Ring. Fittings with missing elements should not be installed.
3. Fitting must be removed from the package when installed and installing should done by competent personnel.
4. Fittings must be used in water systems, not in flammable and combustible gas systems.
5. External factors (dirt, sand, burrs, etc.) in the installation should be cleaned before installation
6. The surface of the pipe to be installed must be cut perpendicularly axis and not to be crushed and smashed, it must be free from particuls, the pipe must be calibrated with the special tool calibrator.
7. Special should be paid that the fittings and the connecting parts are coaxial. The same axial and non-bracing installation should not be aplicated.
8. The pipe to be installed must be clearly seen through the observation holes on the Press Metal Ring, otherwise the installing and pressing process should not be done.
9. Press fitting pressing process must be performed using the diameter and jaw types specified on the Press Metal Ring (TH-H-U).
10. Only suitable teflon tape should be used on the threads of the fittings.
11. Installation Process must only be done with the appropriate size key from the key mouth parts during the installation.
12. Fittings should not be used with the pipe connections without ensure adequate flow and proper control.
13. Non-abrasive materials must be used on the surface of the fittings during cleaning and painting operations.

Press Fittings (For Multilayer Pipes)

DOUBLE NIPPLE

CODE	ØD (mm)	PCS/PACKAGE
7800351001	16 x16	144
7800351002	20 x20	144
7800351003	26 x26	72
7800351004	32 x32	72



DOUBLE REDUCED NIPPLE

CODE	ØD (mm)	PCS/PACKAGE
7800354001	16 x20	144
7800354002	26 x20	72
7800354003	32 x26	72



FEMALE NIPPLE

CODE	ØD (mm)	PCS/PACKAGE
7800355001	16 x1/2"	144
7800355002	20 x1/2"	144
7800355003	20 x3/4"	144
7800355004	26 x3/4"	72
7800355005	26 x1"	72
7800355006	32 x1"	72



MALE NIPPLE

CODE	ØD (mm)	PCS/PACKAGE
7800355101	16 x1/2"	144
7800355102	20 x1/2"	144
7800355103	20 x3/4"	144
7800355104	26 x3/4"	72
7800355105	26 x1"	72
7800355106	32 x1"	72



FEMALE NIPPLE WITH LOOSE NUT

CODE	ØD (mm)	PCS/PACKAGE
7800355201	16 x1/2"	144
7800355202	16 x3/4"	144
7800355203	20 x1/2"	144
7800355204	20 x3/4"	144



Press Fittings(For Multilayer Pipes)



FEMALE ELBOW

CODE	ØD (mm)	PCS/PACKAGE
7800356001	16 x1/2"	72
7800356002	20 x1/2"	72
7800356003	20 x3/4"	72
7800356004	26 x3/4"	54
7800356005	32 x1"	54



MALE ELBOW

CODE	ØD (mm)	PCS/PACKAGE
7800356101	16 x1/2"	72
7800356102	20 x1/2"	72
7800356103	20 x3/4"	72
7800356104	26 x3/4"	54
7800356105	32 x1"	54



ELBOW

CODE	ØD (mm)	PCS/PACKAGE
7800352001	16 x16	72
7800352002	20 x20	72
7800352003	26 x26	54
7800352004	32 x32	54



WALL PLATE ELBOW

CODE	ØD (mm)	PCS/PACKAGE
7800357001	16 x1/2"	72
7800357002	20 x1/2"	72
7800357003	20 x3/4"	72

Press Fittings(For Multilayer Pipes)

FEMALE TE

CODE	ØD (mm)	PCS/PACKAGE
7800358001	16 x1/2" x16	72
7800358002	20 x1/2" x20	72
7800358003	20 x3/4" x20	72
7800358004	26 x3/4" x26	54



MALE TE

CODE	ØD (mm)	PCS/PACKAGE
7800358101	16 x1/2" x16	72
7800358102	20 x1/2" x20	72
7800358103	20 x3/4" x20	72
7800358104	26 x3/4" x26	54



TEE

CODE	ØD (mm)	PCS/PACKAGE
7800353001	16 x16 x16	72
7800353002	20 x20 x20	72
7800353003	26 x26 x26	54
7800353004	32 x32 x32	54



REDUCED TE

CODE	ØD (mm)	PCS/PACKAGE
7800353101	20 x16 x16	72
7800353102	20 x20 x16	72
7800353103	16 x20 x16	72
7800353104	20 x16 x20	72
7800353105	26 x26 x20	54
7800353106	26 x20 x26	54
7800353107	26 x16 x26	54



FIRATPEX Pipes and Fittings

Polyethylene based FIRATPEX Pipes System as the smart product of the plastic technology is the single pipe system which can be used in hot-cold water installations, underfloor heating, portable and clean water systems.

Thanks to their flexible structure, FIRATPEX Pipes can be used comfortably in different forms in different floor, furnishing and wall types and as sheathed in radiator systems which are so-called as portable installation as well as any kind of sanitary installation systems.

FIRATPEX Pipe Systems is the best installation solution for heating different buildings such as business complexes, residents, sports halls, schools, laboratories, chapels, theatres etc.

Due to its nature, polyethylene cannot resist against hot fluids, however, if their molecular chain structure is transformed into crosslink-PE-Xb structure, they become durable against very high temperatures. FIRATPEX Pipes based on cross-linked polyethylene can operate in all temperatures between -100 °C and +110 °C without deterioration in its structural properties.



Service Life of PE-Xb Pipes

Guaranteed service life of Firatpex pipes is 50 years under 12.5 bar pressure at 20 °C. Moreover, Firatpex pipes can achieve 50 years of service life under 7.1 bars at 70 °C.



Sheathed Firatpex Pipes

Sheathed Firatpex Pipes are generally used in radiator systems, also called as portable installation and cold-hot water installations and it is applied by placing a spiral sheath inside the PEX pipe.

Advantages of Sheath (Protective Spiral Pipe)

1. Sheath prevents abrasion of PEX Pipes.
2. Sheath Prevents the impacts that may be directed onto PEX pipes.
3. Sheath ensures easy replacement of pipes without removing flooring if PEX pipes are damaged.
4. Sheath maintains heat insulation and prevents water losing its heat by forming an air gap between PEX pipe and screed concrete.

PE-Xb Pipe Diameter Values

Rated Diameter External Diameter (mm)	Wall Thickness (mm)
14	2.0
16	2.0
17	2.0
18	2.0
20	2.3
25	2.8
32	3.6



FIRATPEX Pipes and Fittings

Crosslink

FIRATPEX Pipes are produced with extrusion method. Later formed into a coil, FIRATPEX Pipes are placed in steam tanks and cured for approx 4 hours. As a result, polymer chains are linked with side chains and turns into one molecule and transformation into cross linked structure is completed.

Crosslink Types

There are different types of pex pipe systems as PEX-a Peroxide, PEX-b Silane and PEX-c Irradiation (Difference between types depends on production method and crosslink ratios stipulated by TS 10762-2 EN ISO 15875-2 Standard).

PE-X_a is also known as peroxidised method. Before extrusion, peroxide is mixed with PE rawmaterial. Crosslink is maintained during production. It is the oldest method known. The crosslink degree must be 70% at least.

PE-X_b is also known as silane method. It is produced with mixing cross linkable High Density Polyethylene which is resistant against heat and pressure and a special liquid called as "silane" at specified ratio. Crosslink is facilitated with steam cure which is a special process after production. The crosslink degree must be 65% at least.

PE-X_c is known as irradiation method. It is produced from High Density Polyethylene rawmaterial having high molecular weight. Cross link is maintained with irradiation process after production. The crosslink degree must be 60% at least.

FIRATPEX Pipe Systems are produced with PE-Xb method which is also known as Silane Method since high performance against temperature and flexibility features.

FIRATPEX Pipe Systems are produced in four different types according to application areas in line with TS 10762-2 EN ISO 15875-2 standard.

1. PEX Pipes with Oxygen Barrier.
2. Self-Sheathed PEX Pipes with Oxygen Barrier.
3. PEX Pipes without Barrier.
4. Self-Sheathed PEX Pipes without Oxygen Barrier.

FIRATPEX Pipes with Oxygen Barrier

Due to oxygen permeability feature of plastic materials, they allow the oxygen penetration into water from outside in heating systems. In such cases, oxidisation and corrosion can be seen in radiator, natural gas boiler, boiler and installation. In order to eliminate this problem, external surfaces of PEX pipes are coated with a bright layer which is insulated against oxygen transmission between inside and outside of pipe with a special method during production, so that their tightness against oxygen is maintained. Therefore, oxygen is prevented to be transmitted into water inside installation and no corrosion and oxidation can certainly be seen.

Oxygen Permeability Amount Determination: DIN 4726

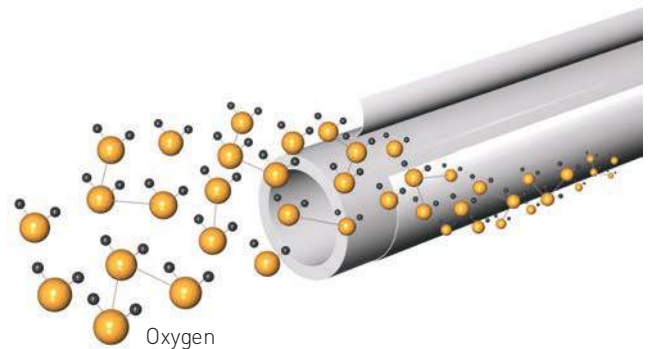

1. Mechanic Properties

*For Ø 16mm

Hydrostatic Tension (MPa)	Test Temperature (°C)	Test Time (Hour)	Test Pressure (Bar)
12	20	1	34.3
4.8	95	1	13.8
4.7	95	22	13.5
4.6	95	165	13.2
4.4	95	1000	12.6

2. Physical and Chemical Properties

	Requirement	Parameter	Time (°C)	Time (Hour)
Dimensional Stability	≤ % 3		120	1
Cross Linking Operation	≥ % 65			
Thermal Stability by means of Hydrostatic Pressure Test	No deformation should occur	2.5 MPa	110 °C	8760

PE-Xb Pipes

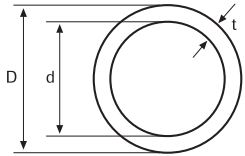

PE-Xb PIPES (With Oxygen Barrier)

CODE	ØD (mm)	d (mm)	t (mm)	L (mm)
74900010014	14	10	2	160
74900010016	16	12	2	160
74900010017	16	11.6	2.2	160
74900010019	17	13	2	160
74900010024	18	14	2	160
74900010025	18	13	2.5	160
74900010020	20	16	2	100
74900010021	20	15.4	2.3	100
74900020027	25	19.4	2.8	160
74900010032	32	24.8	2.6	50

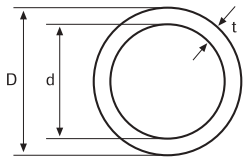

PE-Xb PIPES (Without Oxygen Barrier)

CODE	ØD (mm)	d (mm)	t (mm)	L (mm)
74900020014	14	10	2	160
74900020016	16	12	2	160
74900020017	16	11.6	2.2	160
74900020019	17	13	2	160
74900020024	18	14	2	160
74900020018	18	13	2.5	160
74900020020	20	16	2	100
74900020021	20	15.4	2.3	100
74900020027	25	19.4	2.8	160
74900020032	32	24.8	2.6	50

SPIRAL COVERED PE-Xb PIPES

With Oxygen Barrier*

CODE	ØD (mm)	d (mm)	t (mm)	L (mm)
7490003116K Red	21	16	2	100
7490003116M Blue	21	16	2	100

*Sheathed FIRATPEX pipes with oxygen barrier are produced as red and blue spiral sheathed.

Without Oxygen Barrier*

CODE	ØD (mm)	d (mm)	t (mm)	L (mm)
7490003016K Red	21	16	2	100
7490003016M Blue	21	16	2	100

**Sheathed FIRATPEX pipes without oxygen barrier are produced as red and blue coexed spiral sheathed.

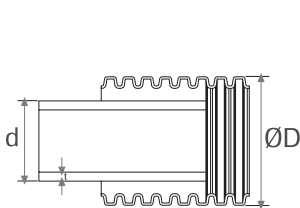

PE-RT Pipes

PERT PIPES (With Oxygen Barrier)

CODE	ØD (mm)	d (mm)	t (mm)	L (mm)
7496000014	14	10	2.2	160
7496000015	16	12	2	160
7496000017	17	11.6	2	160
7496000018	18	13	2.5	160
7496000021	20	16	2	100
7496000025	25	19.4	2.8	160
7496000026	26	19.4	2.8	160
7496000032	32	24.8	3.6	50

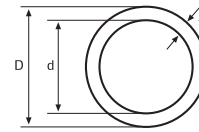

PERT PIPES (Without Oxygen Barrier)

CODE	ØD (mm)	d (mm)	t (mm)	L (mm)
7496000016	16	12	2	160
7496000019	17	11.6	2	160
7496000022	19	16.0	2	100

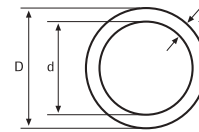

ORANGE PE-RT PIPES (Oxygen Barrier)

CODE	ØD (mm)	d (mm)	t (mm)	L (mm)
7496020016	16	12,4	1.8	160

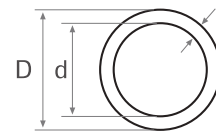

ORANGE PE-RT PIPES (Without Oxygen Barrier)

CODE	ØD (mm)	d (mm)	t (mm)	L (mm)
7496010016	16	12,4	1.8	160

SPIRAL SHEATHS ORANGE PE-RT PIPES

Oxygen Barrier*

CODE	ØD (mm)	d (mm)	t (mm)	L (mm)
7496020016K Kırmızı	21	16	1.8	100
7496020016M Mavi	21	16	1.8	100

With Oxygen Barrier**

KOD	ØD (mm)	d (mm)	t (mm)	L (mm)
7496010016K Kırmızı	21	16	1.8	100
7496010016M Mavi	21	16	1.8	100

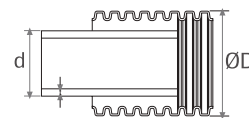

SPIRAL SHEATHS

CODE	ØD (mm)	d (mm)	t (mm)	L (mm)
7321000191K Red	24.5	19.5	2.5	100
7321000191M Blue	24.5	19.5	2.5	100
7321000192K Red	24.5	23.1	2.55	100
7321000192M Blue	24.5	23.1	2.55	100

Ø16mm
P E X
Spiral
Ø20mm
P E X
Spiral

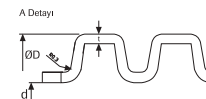

CORNER FIXER*

CODE	ØD (mm)	A (mm)	H (mm)	T (mm)	L (mm)
74910000016	16	24.3	94.5	35.5	119.5

*8x10 box, including chock and ring.

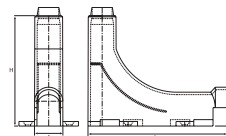

PIPE GROUND FIXER WITH CLIPS

CODE	ØD (mm)	H (mm)	T (mm)	L (mm)
74920000016	16	23	47.3	330

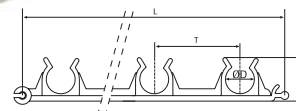

DOUBLE RETAINING CROCHET

CODE	ØD (mm)	H (mm)	A (mm)	L (mm)
7494002525	16	63	8	61.5

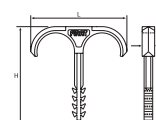

IZOPEX / Pre-Insulated Multilayer Pipes

IZOPEX / Pre-Insulated Multilayer Pipes

Pipes with insulation coating consist of an inner and outer surfaces of TIG Pipes are formed by PE-Xb layers which are resistant to high temperatures, hygienic, resistant to corrosion and impacts taking root of external influences, very smooth and which are preventing sedimentation, providing excellent isolation. In addition to these, a special adhesive and method is used for fixing the inner and outer PE-Xb layers with excellent properties to the aluminum layer.

The insulation coating, made with polyethylene foam, enhances the system energy efficiency and further reduces the noise transmission

The insulation section consists of a polyethylene foam layer protected by a special outer film - red or blue for heating and cooling systems.

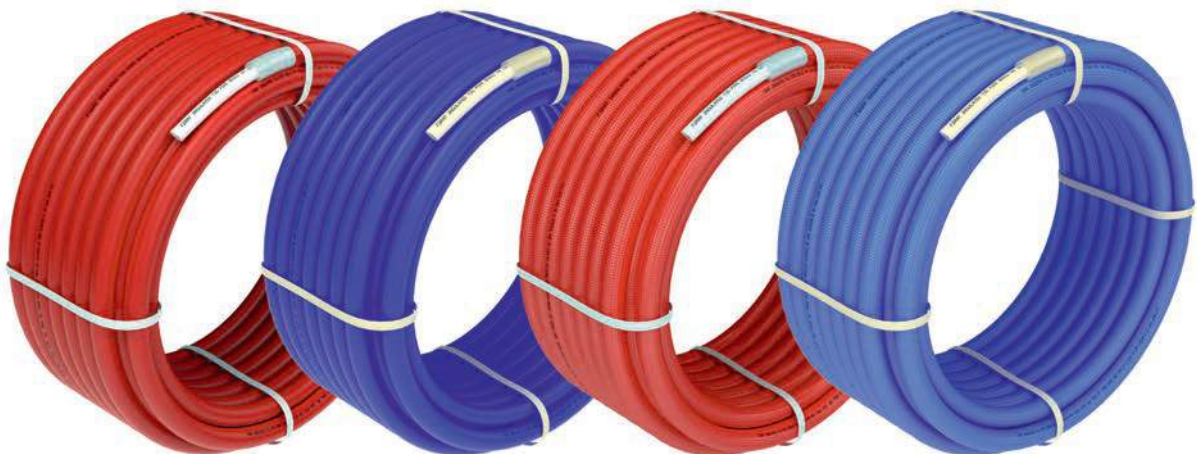
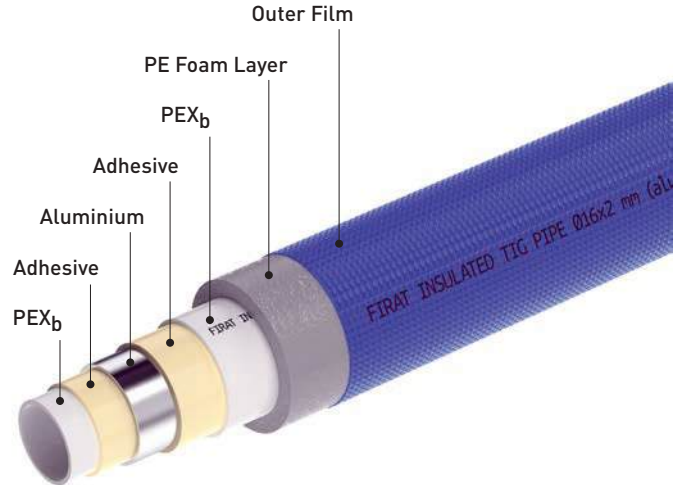

IZOPEX / Pre-Insulated Multilayer Pipes

Specifications for IZOPEX

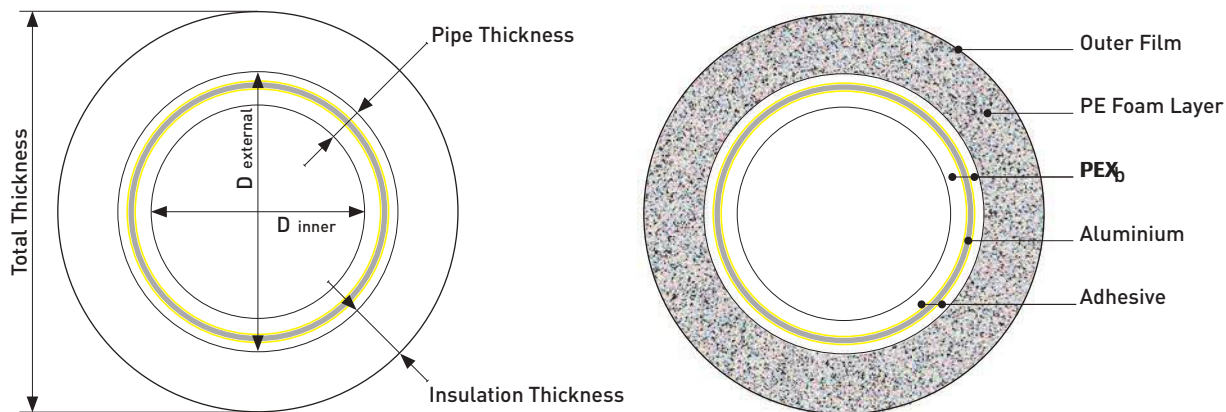

Specifications for IZOPEX

Application classes (EN ISO 21003-1)	1,2
Fire classification	B-s1-d1 (EN 13501-1)
Thickness (round)	6 or 10 mm
Maximum operating temperature	95 °C
Operating conditions for hot applications	95°C 10 Bar
Density at 23 °C	0,30 g/cm ³ (polyethylene foam)
Thermal expansion coefficient	0,025 mm/m0 K
Thermal conductivity	0,40 W/m0 K
Surface roughness	0,006 mm
Softening temperature	135 °C
Permeability to oxygen	0 mg/l
Cross-linking method	PEX _b (silane)
Welding method for aluminu	Tig welding (Tungsten Inert Glass)

Izopex Pipes Diameter And Wall Thicknesses

Pipes (mm)	Diameter External (mm)	Diameter Inner (mm)	Pipe Thickness (mm)	Insilation Thickness (mm)	Total D (minute)	Total Thickness (mm)	L (coil/m)
16	16	12	2	6	28	8	100
	16	12	2	10	36	12	
18	18	14	2	6	30	8	100
	18	14	2	10	38	12	
20	20	16	2	6	32	8	100
	20	16	2	10	40	12	
26	26	20	3	6	42	9	100
	26	20	3	10	50	13	
32	32	26	3	6	44	9	100
	32	26	3	10	52	13	

IZOPEX / Pre-Insulated Multilayer Pipes



IZOPEX INSULATED PEXb PIPES / 6 MM (Straight)

CODE	Color	ØD (mm)	Insulation (mm)	L (mm)
7497006016	White	16	6	50
7497006016K	Red	16	6	50
7497006016M	Blue	16	6	50
7497006018	White	18	6	50
7497006018K	Red	18	6	50
7497006018M	Blue	18	6	50
7497006020	White	20	6	50
7497006020K	Red	20	6	50
7497006020M	Blue	20	6	50
7497006026	White	26	6	50
7497006026K	Red	26	6	50
7497006026M	Blue	26	6	50
7497006032	White	32	6	25
7497006032K	Red	32	6	25
7497006032M	Blue	32	6	25



IZOPEX INSULATED PEXb PIPES / 6 MM (Serrated)

CODE	Color	ØD (mm)	Insulation (mm)	L (mm)
7497006116	White	16	6	50
7497006116K	Red	16	6	50
7497006116M	Blue	16	6	50
7497006118	White	18	6	50
7497006118K	Red	18	6	50
7497006118M	Blue	18	6	50
7497006120	White	20	6	50
7497006120K	Red	20	6	50
7497006120M	Blue	20	6	50
7497006126	White	26	6	50
7497006126K	Red	26	6	50
7497006126M	Blue	26	6	50
7497006132	White	32	6	25
7497006132K	Red	32	6	25
7497006132M	Blue	32	6	25

IZOPEX / Pre-Insulated Multilayer Pipes

IZOPEX INSULATED PEXb PIPES / 10 MM (Straight)

CODE	Color	ØD (mm)	Insulation (mm)	L (mm)
7497010016	White	16	10	50
7497010016K	Red	16	10	50
7497010016M	Blue	16	10	50
7497010018	White	18	10	50
7497010018K	Red	18	10	50
7497010018M	Blue	18	10	50
7497010020	White	20	10	50
7497010020K	Red	20	10	50
7497010020M	Blue	20	10	50
7497010026	White	26	10	50
7497010026K	Red	26	10	50
7497010026M	Blue	26	10	50
7497010032	White	32	10	25
7497010032K	Red	32	10	25
7497010032M	Blue	32	10	25



IZOPEX INSULATED PEXb PIPES / 10 MM (Serrated)

CODE	Color	ØD (mm)	Insulation (mm)	L (mm)
7497010116	White	16	10	50
7497010116K	Red	16	10	50
7497010116M	Blue	16	10	50
7497010118	White	18	10	50
7497010118K	Red	18	10	50
7497010118M	Blue	18	10	50
7497010120	White	20	10	50
7497010120K	Red	20	10	50
7497010120M	Blue	20	10	50
7497010126	White	26	10	50
7497010126K	Red	26	10	50
7497010126M	Blue	26	10	50
7497010132	White	32	10	25
7497010132K	Red	32	10	25
7497010132M	Blue	32	10	25



IZOPEX / Pre-Insulated Multilayer Pipes

IZOPEX INSULATED PERT PIPES / 6 MM (Straight)

CODE	Color	ØD (mm)	Insulation (mm)	L (mm)
7498006016	White	16	6	50
7498006016K	Red	16	6	50
7498006016M	Blue	16	6	50
7498006018	White	18	6	50
7498006018K	Red	18	6	50
7498006018M	Blue	18	6	50
7498006020	White	20	6	50
7498006020K	Red	20	6	50
7498006020M	Blue	20	6	50
7498006026	White	26	6	50
7498006026K	Red	26	6	50
7498006026M	Blue	26	6	50
7498006032	White	32	6	25
7498006032K	Red	32	6	25
7498006032M	Blue	32	6	25



IZOPEX INSULATED PERT PIPES / 6 MM (Serrated)

CODE	Color	ØD (mm)	Insulation (mm)	L (mm)
7498006116	White	16	6	50
7498006116K	Red	16	6	50
7498006116M	Blue	16	6	50
7498006118	White	18	6	50
7498006118K	Red	18	6	50
7498006118M	Blue	18	6	50
7498006120	White	20	6	50
7498006120K	Red	20	6	50
7498006120M	Blue	20	6	50
7498006126	White	26	6	50
7498006126K	Red	26	6	50
7498006126M	Blue	26	6	50
7498006132	White	32	6	25
7498006132K	Red	32	6	25
7498006132M	Blue	32	6	25



IZOPEX / Pre-Insulated Multilayer Pipes

IZOPEX INSULATED PERT PIPES / 10 MM (Straight)

CODE	Color	ØD (mm)	Insulation (mm)	L (mm)
7498010016	White	16	10	50
7498010016K	Red	16	10	50
7498010016M	Blue	16	10	50
7498010018	White	18	10	50
7498010018K	Red	18	10	50
7498010018M	Blue	18	10	50
7498010020	White	20	10	50
7498010020K	Red	20	10	50
7498010020M	Blue	20	10	50
7498010026	White	26	10	50
7498010026K	Red	26	10	50
7498010026M	Blue	26	10	50
7498010032	White	32	10	25
7498010032K	Red	32	10	25
7498010032M	Blue	32	10	25



IZOPEX INSULATED PERT PIPES / 10 MM (Serrated)

CODE	Color	ØD (mm)	Insulation (mm)	L (mm)
7498010116	White	16	10	50
7498010116K	Red	16	10	50
7498010116M	Blue	16	10	50
7498010118	White	18	10	50
7498010118K	Red	18	10	50
7498010118M	Blue	18	10	50
7498010120	White	20	10	50
7498010120K	Red	20	10	50
7498010120M	Blue	20	10	50
7498010126	White	26	10	50
7498010126K	Red	26	10	50
7498010126M	Blue	26	10	50
7498010132	White	32	10	25
7498010132K	Red	32	10	25
7498010132M	Blue	32	10	25



Metal Systems

Production

Metal Fittings are subjected to various processes until they become a finished product from brass rawmaterial.

These processes are lined up as follows:

- Supplied in form of bars, brass rawmaterial is cut to required dimensions and weights using automatic saws and prepared for forging process.
- Heated in high temperature ovens, brass bars are forged with automatic presses and turned into semi-finished product.
- Pressed product is sandblasted and processed in robotic full-automatic machinery and prepared for nickel plating.
- Nickel plated products, accessories and sealingelements are assembled in fully automatic machinery
- All Metal Fittings are subjected to 100% tightness test upon assembly.
- Metal Fittings which pass the tightness test are packaged automatically and made ready for shipping.

Brass

Firat uses special MS 58 Brass as rawmaterial for the production of Metal Fittings. Brass is preferred in production of metal fittings due to its ease of process, extended usage life, high resistance to abrasion and corrosion. Supplied in form of bars, brass rawmaterial is manufactured as per EN 12164 and EN12165 standards.

EPDM O-Ring

Perfect functioning of Firat Metal Fittings can only be ensured by using correct O-Ring in the system. Ethylene Propylene Diene Monomer (EPDM) is used as the most suitable rawmaterial among synthetic rubbers for O-rings used with Firat Metal Fittings. The only gasket which is resistant to air-water oxidation, ozone cracking is the only EPDM rubber product which has permanent deformation values required for tightness between temperatures -40°C and +130°C.

Nickel Plating

Firat Metal Fittings producing with MS 58 Brass are coated with Nickel material and offering to our customers. Thanks to the Nickel Plating, the additional parts gain a bright and beautiful appearance, and the corrosion resistance of their outer surfaces increases, providing longer-term use.



Metal Systems

Radiator Valves

Radiator valves are fittings which used adjust the inlet and outlet flow rate of the heating fluid by being installed on the inlet and outlet parts of the heaters. The body, internal part and connection parts of radiator valves are used MS 58 brass material, besides of PDM O-Ring is used to ensure sealing

Firat metal radiator valves are subjected to the following tests as per TSEK quality criteria.

- External Leakage Test in Closed Position
- Internal Leakage Test in Open and Closed Position
- Pressure Test
- Thickness of Coating Test (It is applied on the material in addition to standard tests.)

Installation and Usage Information for Radiator Valves

- The valve is designed for heating systems. It shall not be used for flammable-burning gas systems.
- System pressure shall not exceed 10 bars and operating temperature shall not exceed 105°C.
- Installation of the valve shall be carried out by a qualified plumber.
- All foreign substances (dirt, sand etc.) in the system shall be cleaned before installation.
- The valve shall only be installed with original fittings.
- Installation direction shall be determined according to the arrow sign on the valve housing which show the flow direction.
- Care should be taken to ensure that the valve and connection parts are on the same axis, and no cumbersome installation that is not on the same axis should be made.
- Threaded parts of the fittings shall be covered with suitable sealing materials (teflon tape).
- The valve shall be tightened from the corresponding section using a suitable wrench during installation. The valve shall not be tightened by using the housing.
- Adjustment knob shall not be forcibly rotated past the end and the valve shall be used in fully open or fully closed positions.
- Abrasive chemicals shall not be used to clean the valve.
- System shall be protected against risk of freezing.
- It shall be protected against external impacts during storage, shipping, installation and operation.
- Useful life established and announced by Ministry is 5 years.



Metal Systems

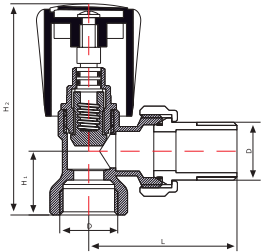

1/2" RADIATOR VALVE (Angled)

CODE	ØD (mm)	G"	H1 (mm)	H2 (mm)	L (mm)	Working Pressure
7800110600	DN 15	1/2"	23	76.25	53.44	PN 10

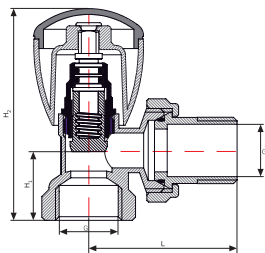

1/2" NEW RADIATOR VALVE (Angled)

CODE	ØD (mm)	G"	H1 (mm)	H2 (mm)	L (mm)	Working Pressure
7800110620	DN 15	1/2"	22	66.60	46.70	PN 10

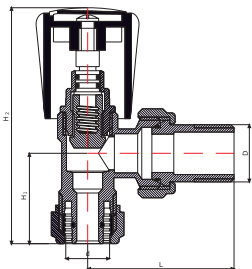

1/2" RADIATOR VALVE (Angled) (Pex Pipe Connection)

CODE	ØD (mm)	G"	H1 (mm)	H2 (mm)	L (mm)	Working Pressure
7800110700	DN15 d:16	1/2"	33	86.20	53.44	PN 10

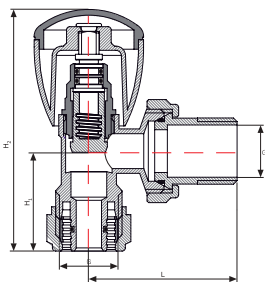

1/2" NEW RADIATOR VALVE (Angled) (Pex Pipe Connection)

CODE	ØD (mm)	G"	H1 (mm)	H2 (mm)	L (mm)	Working Pressure
7800110620	DN 15	1/2"	31.50	76.10	46.70	PN 10

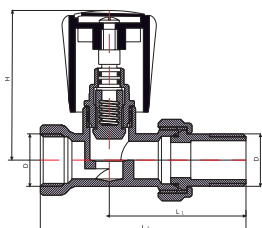

1/2" RADIATOR VALVE (Straight)

CODE	ØD (mm)	G"	H1 (mm)	H2 (mm)	L (mm)	Working Pressure
7800110800	DN 15	1/2"	59.65	54.50	82	PN 10

Metal Systems

1/2" RADIATOR LOCKSHIELD VALVE

CODE	ØD (mm)	G"	H1 (mm)	H2 (mm)	L (mm)	Working Pressure
7800110900	DN 15	1/2"	26	50	56	PN 10

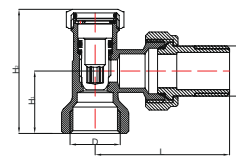

1/2" RADIATOR VALVE SELF SEALED (Angled)

CODE	ØD (mm)	G"	H1 (mm)	H2 (mm)	L (mm)	Working Pressure
7800110650	DN15	1/2"	23	76.15	53.44	PN 10

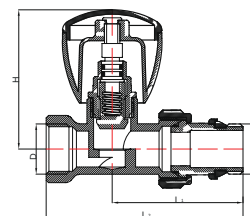

1/2" RADIATOR VALVE SELF SEALED (Angled) (Pex Pipe Connection)

CODE	ØD (mm)	G"	H1 (mm)	H2 (mm)	L (mm)	Working Pressure
7800110750	DN15 d:16	1/2"	33	86.20	53.44	PN 10

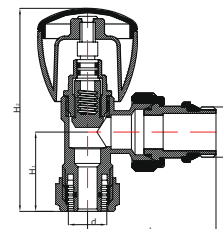

1/2" RADIATOR VALVE SELF SEALED (Straight)

CODE	ØD (mm)	G"	H1 (mm)	H2 (mm)	L (mm)	Working Pressure
7800110850	DN 15	1/2"	82	59.56	54.50	PN 10

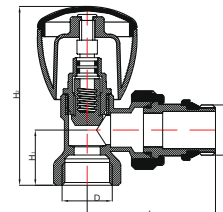

1/2" RADIATOR LOCKSHIELD VALVE SELF SEALED

CODE	ØD (mm)	G"	H1 (mm)	H2 (mm)	L (mm)	Working Pressure
7800110950	DN 15	1/2"	26	50	56	PN 10

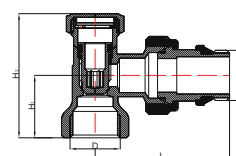

Metal Systems

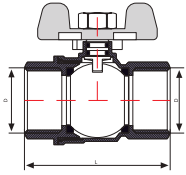

1" FEMALE BALL VALVE (Red or Blue Tap)

CODE	ØD (mm)	G"	L(mm)	Working Pressure
7800111000K Red	DN 25	1"	74.13	PN 25
7800111000M Blue	DN 25	1"	74.13	PN 25

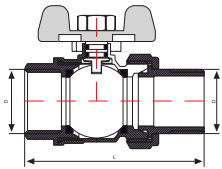

1" MALE BALL VALVE (Red or Blue Tap)

CODE	ØD (mm)	G"	L(mm)	Working Pressure
7800111100K Red	DN 25	1"	92.73	PN 25
7800111100M Blue	DN 25	1"	92.73	PN 25

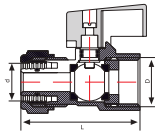

1/2" MINI FEMALE BALL VALVE (Pex Pipe Connection)

CODE	ØD (mm)	G"	L(mm)	Working Pressure
7800111000K Red	DN15 d:16	1/2"	50.60	PN 16
7800111000M Blue	DN15 d:16	1/2"	50.60	PN 16

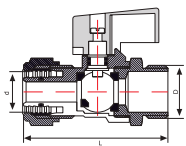

1/2" MINI MALE BALL VALVE (Pex Pipe Connection)

CODE	ØD (mm)	G"	L(mm)	Working Pressure
7800111100K Red	DN15 d:16	1/2"	56.90	PN 16
7800111100M Blue	DN15 d:16	1/2"	56.90	PN 16

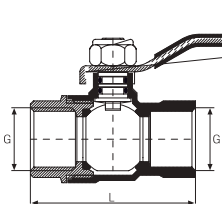

WATER BALL VALVE (PN 10)

CODE	ØD (mm)	G"	L(mm)	Working Pressure
7800150001	DN 25	1/2"	55.30	PN 10
7800150002	DN 25	3/4"	65.50	PN 10
7800150003	DN 25	1"	78.50	PN 10
7800150004	DN 25	1.1/4"	96.70	PN 10
7800150005	DN 25	1.1/2"	107.0	PN 10
7800150006	DN 25	2"	129.0	PN 10

Metal Systems

GAS BALL VALVE

CODE	ØD (mm)	G"	L (mm)
7800160001	DN 25	1/2"	55.30
7800160002	DN 25	3/4"	65.50
7800160003	DN 25	1"	78.50
7800160004	DN 25	1.1/4"	96.70
7800160005	DN 25	1.1/2"	107.0
7800160006	DN 25	2"	129.0

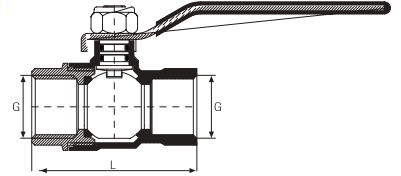

GAS BALL VALVE (Locked)

CODE	ØD (mm)	G"	L (mm)
7800165001	DN 25	1/2"	55.30
7800165002	DN 25	3/4"	65.50
7800165003	DN 25	1"	78.50

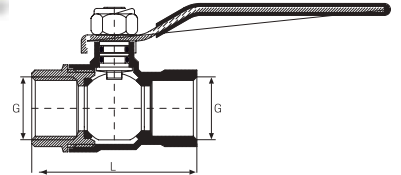

INDUSTRIAL BALL VALVE (PN 25)

CODE	ØD (mm)	G"	L (mm)	Working Pressure
7800170001	DN 25	1/2"	55.30	PN 25
7800170002	DN 25	3/4"	65.50	PN 25
7800170003	DN 25	1"	78.50	PN 25
7800170004	DN 25	1.1/4"	96.70	PN 25
7800170005	DN 25	1.1/2"	107.0	PN 25
7800170006	DN 25	2"	129.0	PN 25

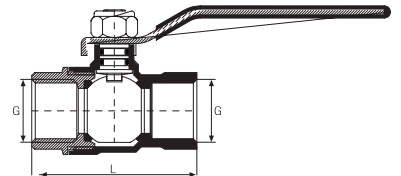

1/2" - 16mm PEX FEMALE SOCKET

CODE	ØD (mm)	G"	L (mm)	Working Pressure
7800110200	DN:1/2"-d:16	1/2"	31	PN 10

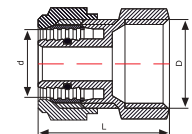

1/2" - 16mm PEX MALE SOCKET

CODE	ØD (mm)	G"	L (mm)	Working Pressure
7800110300	DN:1/2"-d:16	1/2"	33	PN 10

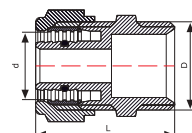

Metal Systems

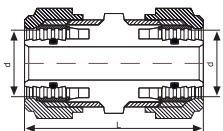

16mm PEX SOCKET

CODE	ØD (mm)	L (mm)	Working Pressure
7800110100	d:16	43	PN 10

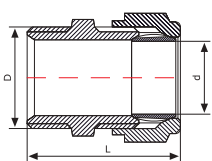

METAL PIPE-RADIATOR CONNECTION SOCKET

CODE	ØD (mm)	G"	L (mm)	Working Pressure
7800110400	DN:1/2"-d:15	1/2"	31.54	PN 10

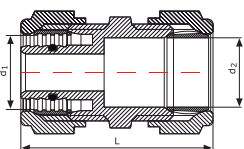

16mm PEX-METAL PIPE CONNECTION SOCKET

CODE	ØD (mm)	L (mm)	Working Pressure
7800110500	d1:16-d 2:15	41.55	PN 10

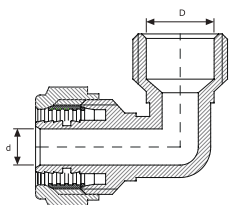

1/2"-16mm MALE THREADED ELBOW (Pex Pipe Connection)

CODE	ØD (mm)	G"	Working Pressure
7800110000	DN:1/2"-d:16	1/2"	PN 10



RADIATOR CONNECTION PIPE (With Socket)

CODE	ØD (mm)	L (mm)
7800300040	16	400
7800300060	16	600
7800300090	16	900



RADIATOR CONNECTION PIPE (With Elbow)

CODE	ØD (mm)	L (mm)
7800301040	16	400
7800301060	16	600
7800301090	16	900

Metal Systems

1" COLLECTOR (Red-Blue)

CODE	Outputs	ØD (mm)	G"	L(mm)	Working Pressure
7800200200	2	DN 25	1"	108	PN 16
7800200300	3	DN 25	1"	158	PN 16
7800200400	4	DN 25	1"	208	PN 16
7800200500	5	DN 25	1"	258	PN 16
7800200600	6	DN 25	1"	308	PN 16
7800200700	7	DN 25	1"	358	PN 16
7800200800	8	DN 25	1"	408	PN 16
7800200900	9	DN 25	1"	458	PN 16
7800201000	10	DN 25	1"	508	PN 16
7800201100	11	DN 25	1"	558	PN 16
7800201200	12	DN 25	1"	608	PN 16

Plug and Mechanical Purge are mounted on the product.

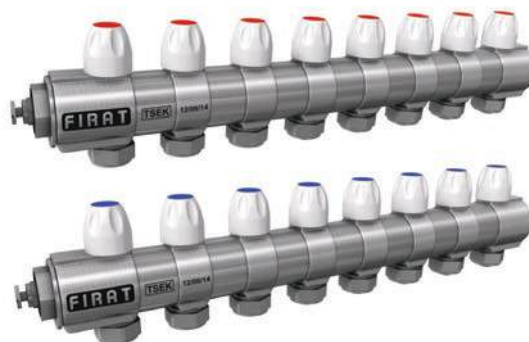

COLLECTOR WITH MINI BALL VALVE (Red-Blue)

CODE	Outputs	ØD (mm)	G"	L(mm)	Working Pressure
7800210200	2	DN 25	1"	108	PN 16
7800210300	3	DN 25	1"	158	PN 16
7800210400	4	DN 25	1"	208	PN 16
7800210500	5	DN 25	1"	258	PN 16
7800210600	6	DN 25	1"	308	PN 16
7800210700	7	DN 25	1"	358	PN 16
7800210800	8	DN 25	1"	408	PN 16
7800210900	9	DN 25	1"	458	PN 16
7800211000	10	DN 25	1"	508	PN 16
7800211100	11	DN 25	1"	558	PN 16
7800211200	12	DN 25	1"	608	PN 16

Plug and Mechanical Purge are mounted on the product.

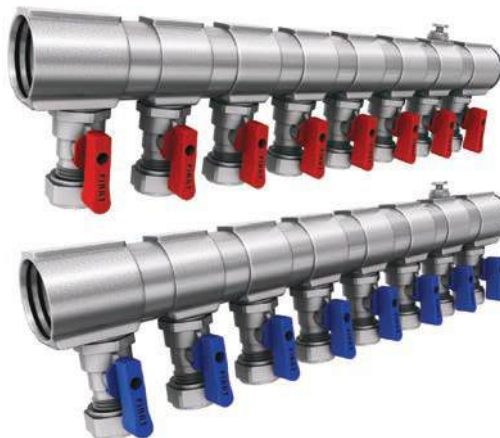

COLLECTOR CLAMP SET

CODE	ØD (mm)	L (mm)
7800220000	DN 25	300



PPRC Pipes and Fittings

TS 13715
 TS 9937 - TS EN ISO 15874
 TS 9937 - TS EN ISO 15874-2
 TS 9937 - TS EN ISO 15874-3



PPRC Pipe



PPRC Composite Pipe

PPRC Pipes

Made of PP-R (Polypropylene Random Copolymer) Type 3 class raw material FIRAT PPRC Pipes and Fittings, which are manufactured pursuant to TS 9937, TSEN ISO 15874, DIN 8077, DIN 8078, DVGW W544 standards, can be employed in any kind of in building hot and cold water installations. PPRC Pipes and Fittings have a minimum lifespan of 50 years when used under suitable pressure and temperature values.

COMPOSITE Pipes

1. Since Firat fiberglass added PP-R pipes have a thermal expansion coefficient close to foiled pipes, they can be used in areas where foiled pipes are utilized.
2. Welding of Firat fiberglass added PP-R pipes are similar to normal pipes. Since they do not require trimming, they provide 30% faster application compared to foiled pipes.
3. Firat fiberglass added PP-R pipes do not cause condensation and elongation in systems where heating and cooling is used together.

Welding Specifications for PPRC Pipes

Outer Diameter (mm)	Welding Depth (mm)	Heating Period (sec)*	Welding Period (mm)	Cooling Period (minute)
20	20	20	20	20
25	25	25	25	25
32	32	32	32	32
40	40	40	40	40
50	50	50	50	50
63	63	63	63	63
75	75	75	75	75
90	90	90	90	90
110	110	110	110	110
125	125	125	125	125
160	160	160	160	160

*If ambient temperature is below +5°C, Heating Period should be prolonged at a rate of 50%.

PPRC, PPRC and Composite Pipes Clamp Spacings

Temperature Difference T (°C)	Ø 20 mm			Ø 25 mm			Ø 32 mm			Ø 40 mm			Ø 50 mm			Ø 63 mm			Ø 75 mm			Ø 90 mm			Ø 110 mm		
	PPRC Pipe	Foiled Pipe	Composite Pipe	PPRC Pipe	Foiled Pipe	Composite Pipe	PPRC Pipe	Foiled Pipe	Composite Pipe	PPRC Pipe	Foiled Pipe	Composite Pipe	PPRC Pipe	Foiled Pipe	Composite Pipe	PPRC Pipe	Foiled Pipe	Composite Pipe	PPRC Pipe	Foiled Pipe	Composite Pipe	PPRC Pipe	Foiled Pipe	Composite Pipe	PPRC Pipe	Foiled Pipe	Composite Pipe
0	85	155	115	105	170	130	125	195	150	140	220	165	165	245	185	190	270	215	205	285	248	220	300	260	250	325	280
20	60	120	90	75	130	100	90	150	115	100	170	130	120	190	145	140	210	165	150	220	185	160	230	200	180	250	215
30	60	120	90	75	130	100	90	150	115	100	170	130	120	190	145	140	210	165	150	220	185	160	230	200	180	240	210
40	60	110	80	70	120	90	80	140	105	90	160	120	110	180	135	130	200	155	140	210	175	150	220	190	170	210	200
50	60	110	80	70	120	90	80	140	105	90	160	120	110	180	135	130	200	155	140	210	175	150	220	190	170	210	180
60	55	100	75	65	110	85	75	130	100	85	150	115	100	170	130	115	190	145	125	200	165	140	210	180	160	200	175
70	50	90	65	60	100	75	75	120	90	80	140	105	95	160	120	105	180	135	115	190	155	125	200	175	140	200	175



PPRC Pipes and Fittings

Service Lives of PPRC, PPRC Aluminium Foiled and Composite Pipes used in Water Installations

Service Lives (Year)	Operating Pressure [Bar]						
	1	5	10	25	50	65	70
1	30.0	25.5	21.5	18.3	15.4	14.6	13.0
5	28.1	23.9	20.2	17.0	14.3	13.6	11.9
10	27.3	23.2	19.6	16.5	13.8	13.1	11.7
25	26.5	22.3	18.8	15.9	13.3	12.6	10.1
50	25.7	21.8	18.3	15.4	12.7	11.1	08.5
Temperature (°C)	20	30	40	50	60	65	70

Cold Water

Reference Standard: DIN 2000

Hot Water

Service Lives of PPRC Pipes used in Heating Systems

Usage Period	Temperature (°C)	Service Life (Year)	Operating Pressure (Bar)
30 days/year	75	5	17.27
		10	13.79
		25	11.74
		45	10.18
	80	5	13.50
		10	13.80
		25	11.14
		42.5	9.79
	85	5	12.42
		10	11.87
		25	10.14
		37.5	9.18
90	5	11.39	
	10	10.94	
	25	8.86	
	35	8.16	
60 days/year	75	5	14.11
		10	13.57
		25	11.58
		45	10.05
	80	5	13.12
		10	12.54
		25	10.56
		40	9.41
	85	5	12.03
		10	11.52
		25	9.22
		35	8.48
90	5	11.04	
	10	9.76	
	25	7.81	
	30	7.460	
90 days/year	75	5	14.02
		10	13.38
		25	11.33
		45	9.82
	80	5	12.90
		10	12.35
		25	10.05
		37.5	9.08
	85	5	11.81
		10	10.72
		25	8.58
		32.5	8.03
90	5	10.59	
	10	8.96	
		25	7.17

Do's and Don'ts in PPRC, PPRC Aluminium Foiled and Composite Pipes and Fittings

- At the end of folio stripping process, no foil particles should remain at welding distance.
- Hot air should be used in joints requiring bending process up to 30°, and 45° joints should be used in joint above 30° degrees.
- In metal fittings applications, excessive tightening should be avoided and teflon tape should be used instead of cannabis.
- Pipes should be cut by a sharp pipe clippers perpendicular to pipe axis.
- No welding should be performed on dirty pipes and fittings; pipes and fittings deformed and cracked at cutting points should not be used.
- Pipes should be protected against all kinds of blow and strike impacts.
- Conical toothed parts should not be employed at joints.
- Installation should be protected against the risk of freezing. If installation shall not be used after testing process, water inside the installation must absolutely be discharged.
- If teflons on threaders are run out or out of order, welding should not be employed (Teflon lifespan is around 2-3 household applications).
- Welding rest period should be obeyed, pipes and fittings should not be rotated during melting process.
- Measures should be taken against steam pressure accumulation in gas heater installations.
- Pipes and fittings should not be exposed to direct sunlight for long periods.
- Raw material PP-R does not contain strength stabilizer against UV rays. Maximum period of storage in an environment exposed to sunlight is six months.
- After the installation is completed, pipes and fittings should be isolated against UV rays and freezing at the sections remained outside the building.



PPRC Pipes and Fittings

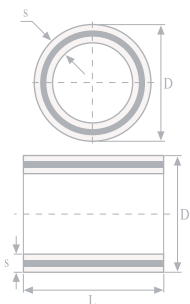
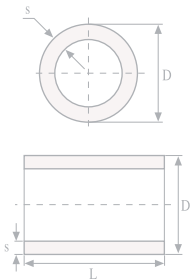
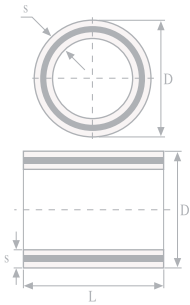
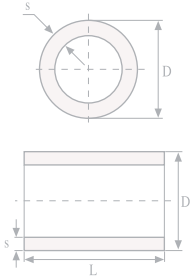

PPRC PN25 PIPES

CODE	ØD (mm)	(mmØ)	L(m)
7700020020	20	3.4	4
7700020025	25	4.2	4
7700020032	32	5.4	4
7700020040	40	6.7	4
7700020050	50	8.3	4
7700020063	63	10.5	4
7700020075	75	12.5	4
7700020090	90	15	4
7700020110	110	18.3	4
7700020126	125	20.8	4
7700020127	160	26.6	4

COMPOSITE PN25 PIPES (With Fiber Glass)

CODE	ØD (mm)	S (mm)	L(m)
7700023020	20	3.4	4
7700023025	25	4.2	4
7700023032	32	5.4	4
7700023040	40	6.7	4
7700023050	50	8.3	4
7700023063	63	10.5	4
7700023075	75	12.5	4
7700023090	90	15	4
7700023110	110	18.3	4
7700023126	125	20.8	4
7700023175	160	26.6	4

PPRC PN20 PIPES

CODE	ØD (mm)	S (mm)	L(m)
7700014020	20	2.8	4
7700014025	25	3.5	4
7700014032	32	4.4	4
7700014040	40	5.5	4
7700014050	50	6.9	4
7700014063	63	8.6	4
7700014075	75	10.3	4
7700014090	90	12.3	4
7700014110	110	15.1	4
7700014125	125	17.1	4
7700014160	160	21.9	4

COMPOSITE PN20 PIPES (With Fiber Glass)

CODE	ØD (mm)	S (mm)	L(m)
7700024020	20	2.8	4
7700024025	25	3.5	4
7700024032	32	4.4	4
7700024040	40	5.5	4
7700024050	50	6.9	4
7700024063	63	8.6	4
7700024075	75	10.3	4
7700024090	90	12.3	4
7700024110	110	15.1	4
7700024126	125	17.1	4
7700024160	160	21.9	4

PPRC Pipes and Fittings

ELBOW (90°)

CODE	ØD (mm)	d	l ₁ (mm)
7711000020	20	19.5	14.5
7711000025	25	24.5	16
7711000032	32	31.5	18
7711000040	40	39.4	20.5
7711000050	50	49.4	23.5
7711000063	63	62.5	27.4
7711000075	75	74.2	31
7711000090	90	89.2	35.5
7711000110	110	109	41.5
7711000125	125	123.5	46
7711000160	160	158.2	58

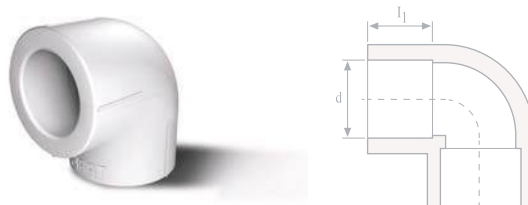

ELBOW (45°)

CODE	ØD (mm)	d	l ₁ (mm)
7711001020	20	19.5	14.5
7711001025	25	24.5	16
7711001032	32	31.5	18
7711001040	40	39.4	20.5
7711001050	50	49.4	23.5
7711001063	63	62.5	27.4



ELBOW (90° Female-Male)

CODE	ØD (mm)	d ₁ -d ₂ (mm)	l ₁ -l ₂ (mm)
7711002020	20	20-19.5	16-16
7711002025	25	25-24.5	16-16
7711002032	32	32-31.5	18.1-18.1

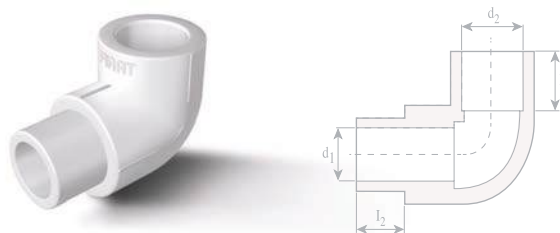

ELBOW (45° Female-Male)

CODE	ØD (mm)	d ₁ (mm)	d ₂ (mm)
7711002120	20	13.2	19.5
7711002125	25	16.6	24.5
7711002132	32	21.2	31.5



REDUCING ELBOW (90° Female-Female)

CODE	ØD (mm)	d ₁ -d ₂ (mm)	l ₁ -l ₂ (mm)
7724025020	20-25	19.3-24.3	16-18
7724032025	25-32	24.3-31.3	18-20

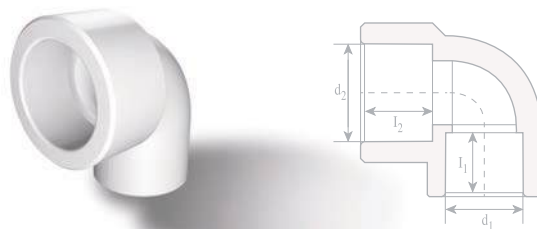

PPRC Pipes and Fittings

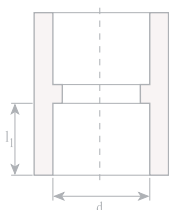

SOCKET

CODE	ØD (mm)	d	l (mm)
772100020	20	19.5	14.5
772100025	25	24.5	16
772100032	32	31.5	18
772100040	40	39.4	20.5
772100050	50	49.4	23.5
772100063	63	62.5	27.4
772100075	75	74.2	31
772100090	90	89.2	35.5
772100110	110	109	41.5
772100125	125	123.5	46
772100160	160	158.2	58

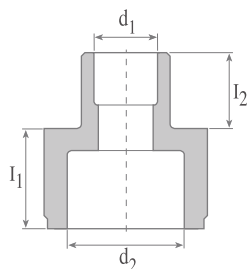

REDUCING SOCKET (Female-Male)

CODE	ØD (mm)	d1-d2 (mm)	l1-l2 (mm)
7722025020	25-20	19.5 - 25	15 - 18
7722032020	32-20	19.5 - 32	15 - 20
7722032025	32-25	24.5 - 32	18 - 20
7722040020	40-20	39.45 - 20	20.5 - 22.5
7722040025	40-25	39.45 - 25	20.5 - 22.5
7722040032	40-32	31.3 - 32	20.5 - 22.5
7722050020	50-20	19.5 - 50	16 - 24
7722050025	50-25	24.5 - 50	18 - 24.5
7722050032	50-32	31.5 - 50	20.5 - 24
7722050040	50-40	39.5 - 50	22 - 24
7722063025	63-25	24.5 - 63	20.5 - 35
7722063032	63-32	31.5 - 63	27.5 - 35
7722063040	63-40	39.4 - 63	22.5 - 35
7722063050	63-50	49.5 - 63	23.5 - 35
7722075050	75-50	49.45 - 75	30 - 37
7722075063	75-63	62.5 - 75	30 - 40.5
7722075075	90-75	74.25 - 90	31 - 35.5
7722075090	110-90	89.2 - 110	35.5 - 44.5
7722125110	125-110	108.6 - 123.5	42 - 46
7722160125	160-125	123.5 - 158.2	46 - 58

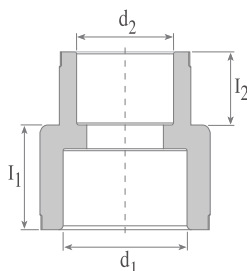

REDUCING SOCKET (Female-Female)

CODE	ØD (mm)	d1-d2 (mm)	l1-l2 (mm)
7723025020	25-20	24.5 - 19.5	18 - 15
7723025025	32-25	31.5 - 24.5	20 - 18

PPRC Pipes and Fittings

PLASTIC UNION

CODE	ØD (mm)	d (mm)	d ₂ (mm)
7744000020	20	19.3	16
7744000025	25	24.3	18
7744000032	32	31.3	21

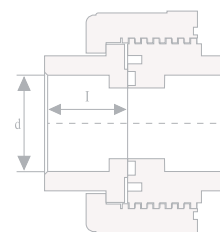

T-PIECE

CODE	ØD (mm)	d ₁ (mm)	l ₁ (mm)	k (mm)
7741000020	20	19.5	14.5	11
7741000025	25	24.5	16	13.5
7741000032	32	31.5	18	17
7741000040	40	39.4	20.5	21
7741000050	50	49.4	23.5	27
7741000063	63	62.5	27.4	32.5
7741000075	75	74.2	31	41
7741000090	90	89.2	35.5	46
7741000110	110	109	41.5	56
7741000125	125	123.5	46	65.5
7741000160	160	158.2	58	85

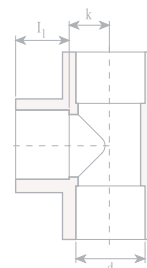

REDUCING T-PIECE

CODE	ØD (mm)	d ₁ (mm)	d ₂ (mm)	d ₂ (mm)
7742252020	25-20-20	24.5	19.5	19.5
7742252025	25-20-25	24.5	19.5	24.5
7742252520	25-25-20	24.5	24.5	19.5
7742322020	32-20-25	31.5	19.5	19.5
7742322025	32-20-25	31.5	19.5	24.5
7742322525	32-25-25	31.5	24.5	24.5
7742322032	32-20-32	31.5	19.5	31.5
7742322520	32-25-20	31.5	24.5	19.5
7742322532	32-25-32	31.5	24.5	31.5
7742402040	40-20-40	39.4	19.5	39.4
7742402540	40-25-40	39.4	24.5	39.4
7742403240	40-32-40	39.4	31.5	39.4
7742502050	50-20-50	49.4	19.5	49.4
7742502550	50-25-50	49.4	24.5	49.4
7742503250	50-32-50	49.4	31.5	49.4
7742504050	50-40-50	49.4	39.4	49.4
7742632563	63-25-63	62.5	24.5	62.5
7742633263	63-32-63	62.5	31.5	62.5
7742634063	63-40-63	62.5	39.4	62.5
7742635063	63-50-63	62.5	49.4	62.5

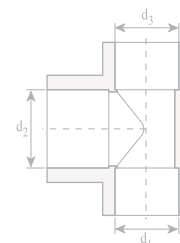

PPRC Pipes and Fittings

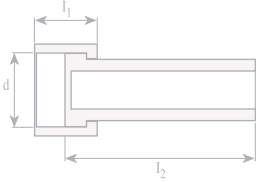

TRANSITION NIPPLE (Female)

CODE	ØD (mm)	d (mm)	l ₁ (mm)	l ₂ (mm)	G"
7778025254	25	24.5	20.5	60	3/4"

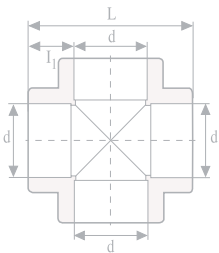

CROSS-T

CODE	ØD (mm)	d (mm)	l ₁ (mm)	L (mm)
7735000020	20	19.5	14.5	51
7735000025	25	24.5	16	59
7735000032	32	31.5	18	70
7735000040	40	39.4	20.5	83

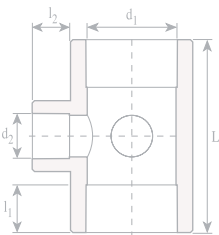

REDUCING CORNERT-PIECE

CODE	ØD (mm)	d ₁ (mm)	d ₂ (mm)	l ₁ (mm)	l ₂ (mm)	L (mm)
7743322020	32-20-20-32	31.5	19.5	18.1	14.5	69.5
7743322525	32-25-25-32	31.5	24.5	18.1	16	69.5
7743402020	40-20-20-40	39.4	19.5	20.5	14.5	82.5
7743402525	40-25-25-40	39.4	24.5	20.5	16	82.5

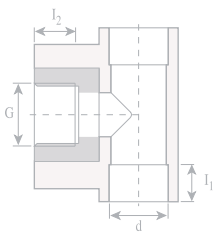

T-ROUND (Female Threaded)

CODE	ØD (mm)	d (mm)	l ₁ (mm)	l ₂ (mm)	G"
7752020127	20	19.5	14.5	13	1/2"
7752020191	20	19.5	14.5	13.5	3/4"
7752025127	25	24.5	16	13	1/2"
7752040191	25	24.5	16	13.5	3/4"
7752032127	32	31.5	16	13.5	1/2"
7752032191	32	31.5	18	13.5	3/4"

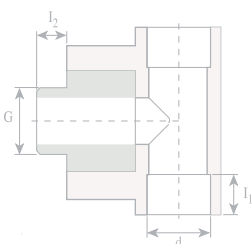

T-ROUND (Male Threaded)

CODE	ØD (mm)	d (mm)	l ₁ (mm)	l ₂ (mm)	G"
7754020127	20	19.5	14.5	13.5	1/2"
7754025191	20	14.5	16	13.5	3/4"
7754020191	25	19.5	14.5	13.5	3/4"
7754025127	25	24.5	18	13.5	1/2"
7754032127	32	31.5	18	13.5	1/2"
7754032191	32	31.5	18	13.5	3/4"

PPRC Pipes and Fittings

SOCKET (Female Threaded)

CODE	ØD (mm)	d (mm)	l ₁ (mm)	l ₂ (mm)	G"
7762020127	20	19.5	14.5	13	1/2"
7762020191	20	19.5	14.5	13.5	3/4"
7762025127	25	24.5	16	13	1/2"
7762025191	25	24.5	16	13.5	3/4"
77962032127	32	31.5	18.5	18.5	1/2"
77962032191	32	31.5	18.5	18.5	3/4"

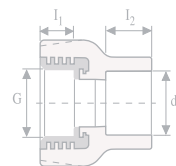

SOCKET (Male Threaded)

CODE	ØD (mm)	d (mm)	l ₁ (mm)	l ₂ (mm)	G"
7764020127	20	19.5	14.5	13	1/2"
7764020191	20	19.5	14.5	13.5	3/4"
7764025127	25	24.5	16	16	1/2"
7764025191	25	24.5	16	16	3/4"
77963032254	32	31,5	18,5	18,5	1"
77963032127	32	31,5	18,5	18,5	1/2"
77963032191	32	31,5	18,5	18,5	3/4"

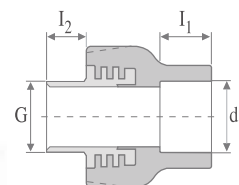

ELBOW (Female Threaded)

CODE	ØD (mm)	d (mm)	l ₁ (mm)	l ₂ (mm)	G"
7772020127	20	19.5	14.5	13	1/2"
7772020191	20	19.5	14.5	13.5	3/4"
7772025127	25	24.5	16	13	1/2"
7772040191	25	24.5	16	13.5	3/4"
7772032192	32	31.5	18	13.5	1/2"
7772032191	32	31.5	18	13.5	3/4"

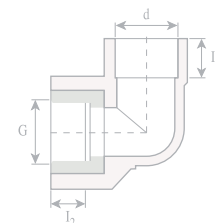

ELBOW (Male Threaded)

CODE	ØD (mm)	d (mm)	l ₁ (mm)	l ₂ (mm)	G"
7774020127	20	19.5	14.5	13.5	1/2"
7774020191	20	19.5	14.5	13.5	3/4"
7774025127	25	24.5	16	13.5	1/2"
7774025191	25	24.5	16	13.5	3/4"
7774032192	32	31.5	18	13.5	1/2"
7774032191	32	31.5	18	13.5	3/4"

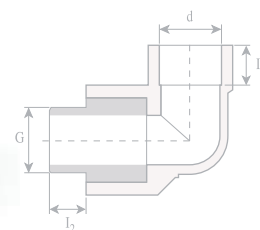

ELBOW HEXAGONAL (Female Threaded)

CODE	ØD (mm)	d (mm)	l ₁ (mm)	l ₂ (mm)	G"
7772120127	20	19.5	14.5	13	1/2"
7772125127	25	24.5	16	13	1/2"

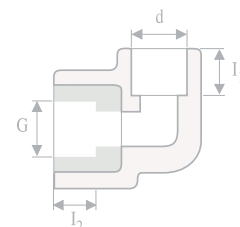

PPRC Pipes and Fittings

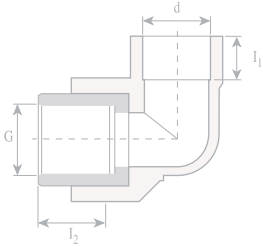

ELBOW HEXAGONAL (Female Threaded)

CODE	ØD (mm)	d (mm)	l ₁ (mm)	l ₂ (mm)	G"
7771032254	32	31.5	18	18	1"
7771040318	40	39.4	20.5	20	1.1/4"
7771050381	50	49.4	23.5	20	1.1/4"

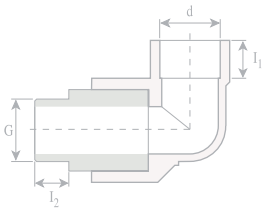

ELBOW HEXAGONAL (Male Threaded)

CODE	ØD (mm)	d (mm)	l ₁ (mm)	l ₂ (mm)	G"
7773032254	32	31.5	18	19	1"
7773040318	40	39.4	20.5	19	1.1/4"
7773050381	50	49.4	23.5	21.3	1.1/4"

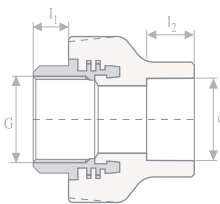

SOCKET HEXAGONAL (Female Threaded)

CODE	ØD (mm)	d (mm)	l ₁ (mm)	l ₂ (mm)	G"
7761032254	32	31.5	18	181	1"
7761040318	40	39.45	20.5	20	1.1/4"
7761050381	50	49.45	23.5	20	1.1/2"
7761063508	63	62.5	27.5	25	2"
7761075635	75	74.2	31	27.5	2.1/2"
7761090762	90	89.9	35.5	28.5	3"
77611101016	110	109	46	38.5	4"

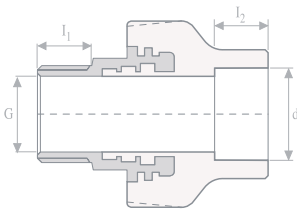

SOCKET HEXAGONAL (Male Threaded)

CODE	ØD (mm)	d (mm)	l ₁ (mm)	l ₂ (mm)	G"
7763032254	32	31.5	18	19	1"
7763040318	40	39.45	20.5	19	1.1/4"
7763050381	50	49.45	23.5	21.3	1.1/2"
7763063508	63	62.5	27.5	23	2"
7763075635	75	74.2	31	23	2.1/2"
7763090762	90	89.9	35.5	26	3"
77631101016	110	109	46	38.5	4"

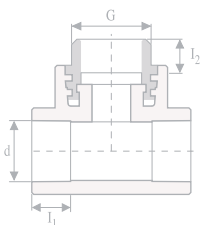

ELBOW UNDER PLASTER (Female Threaded)

CODE	ØD (mm)	d (mm)	l ₁ (mm)	l ₂ (mm)	G"
7772120127	20	19.5	14.5	13	1/2"
7772125127	25	24.5	16	13	1/2"
7751032254	32	31.5	18	16	1"

PPRC Pipes and Fittings

TRANSITION SOCKET (Female Threaded)

CODE	ØD(mm)	d(mm)	L(mm)	G"
7765020191	20	19.5	40	1/2"
7765025191	25	24.5	45	3/4"
7765032191	32	31.5	48.5	1"
7765040191	40	39.45	52	1/4"
7765050191	50	49.4	58.1	1.1/2"
7765063191	63	62.5	67.5	2"

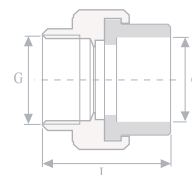

TRANSITION SOCKET (Male Threaded)

CODE	ØD (mm)	d(mm)	L(mm)	G"
7766020191	20	19.5	50.5	1/2"
7766025191	25	24.5	53	3/4"
7766025254	25	24.5	53	1"
7766032191	32	31.5	64	1"
7766040191	40	39.45	70.5	1.1/4"
7766050191	50	49.4	77.9	1.1/2"
7766063191	63	62.5	89.5	2"

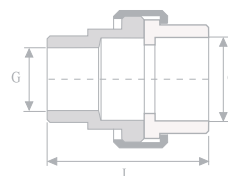

STOP VALVE

CODE	ØD(mm)	d(mm)	h(mm)	L(mm)	G"
7782020127	20	19.5	41.5	64.5	1/2"
7782025191	25	24.5	45	88	3/4"
7782032254	32	31.5	56.5	94	1"
7782040318	40	39.4	67.7	94.6	1"

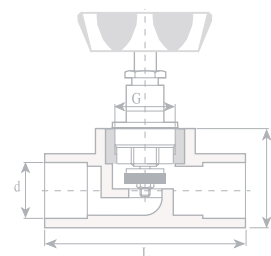

CHROME-PLATED HIDDEN VALVE

CODE	ØD (mm)	d(mm)	h(mm)	L(mm)	G"
7784020127	20	19.5	41.5	64.5	1/2"
7784025191	25	24.5	45	88.5	3/4"
7784032254	32	31.5	56.5	94	1"

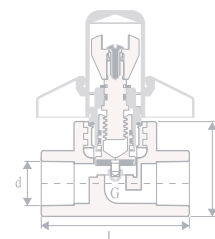

CHROME-PLATED VALVE

CODE	ØD (mm)	d(mm)	h(mm)	L(mm)	G"
7782010127	20	19.5	41.5	64.5	1/2"
7782015191	25	24.5	45	88	3/4"
7782016254	32	31.5	56.5	94	1"

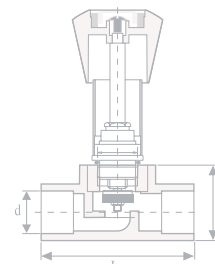

PPRC Pipes and Fittings

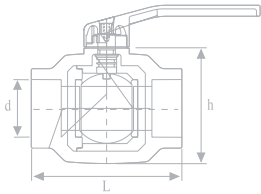

BALL VALVE (Metal Handle)

CODE	ØD(mm)	d(mm)	h(mm)	L(mm)	G"
7783020127	20	19.5	50	65	1/2"
7783025191	25	24.5	55	73	3/4"
7783032254	32	31.5	65	77.5	1"
7783040318	40	39.5	71	91.5	1.1/4"
7783050381	50	49.4	88	117	1.1/2"
7783063508	63	62.5	110	136	2"
7783075635	75	74.7	130.75	155.5	2.1/2"

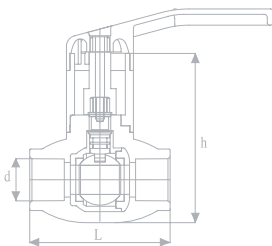

BALL VALVE (Metal Handle & Long Type)

CODE	ØD(mm)	d(mm)	h(mm)	L(mm)	G"
7783520127	20	31.5	79	87.5	1/2"
7783525191	25	39.5	84.5	103.5	3/4"

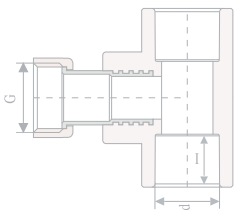

T - WITH LOOSE NUT

CODE	ØD(mm)	d(mm)	L(mm)	G"
7776020127	20	19.5	16	1/2"
7776025191	25	24.5	18	3/4"
7776032254	32	31.5	20	1"

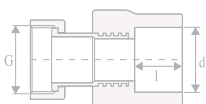

SOCKET WITH LOOSE NUT

CODE	ØD(mm)	d(mm)	l(mm)	G"
7775020127	20	19.5	16	1/2"
7775025191	25	24.5	18	3/4"
7775032254	32	31.5	20	1"

PPRC Pipes and Fittings

ELBOW WITH LOOSE NUT

CODE	ØD (mm)	d (mm)	l (mm)	G"
7777020127	20	19.5	16	1/2"
7777025191	25	24.5	18	3/4"
7777032254	32	31.3	20	1"

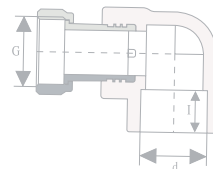

Y - FILTER

CODE	ØD (mm)	d1 - d2 (mm)	l (mm)	G"
7781020127	20	19.5 - 20	16	1/2"
7781025191	25	24.5 - 25	18	3/4"
7781032254	32	31.5 - 32	20	1"

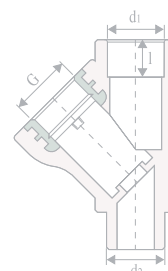

RADIATOR VALVE (Angled)

CODE	ØD (mm)	d (mm)	l (mm)	G"
7791020127	20	19.5	14.5	1/2"
7791025191	25	24.5	18	3/4"

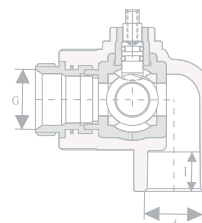

RADIATOR VALVE (Angled)

CODE	ØD (mm)	d (mm)	l (mm)	G"
7792020127	20	19.5	14.5	1/2"
7792025191	25	24.5	18	3/4"

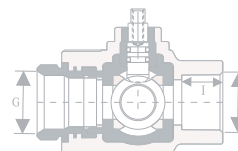

ARMATURE STABILIZER

CODE	ØD (mm)	d (mm)	B (mm)	A (mm)	L (mm)	G"
7734000000	26	48.5	50	50	260	1/2"

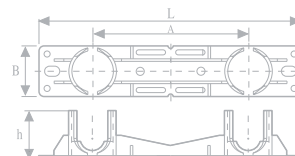
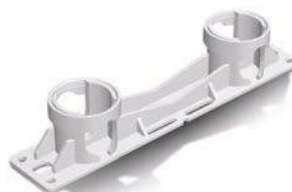

PPRC Pipes and Fittings

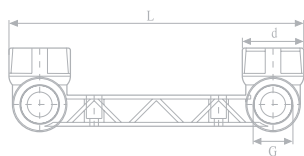

ARMATURE CONNECTOR

CODE	ØD (mm)	d (mm)	g (mm)	l (mm)	G"
7780020128	20	30.0	19.5	189	1/2"
7780025127	25	39.5	24.5	190	1/2"

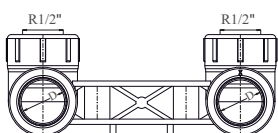

ARMATURE CONNECTOR

CODE	ØD (mm)	d (mm)	g (mm)	l (mm)	G"
7781021127	20	30.0	19.5	189	1/2"
7781025127	25	39.5	24.5	190	1/2"

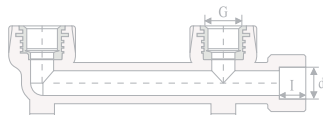

ARMATURE CONNECTOR FOR BIDET

CODE	ØD (mm)	d (mm)	l (mm)	G"
7780120127	20	19.5	16	1/2"
7780125127	25	24.5	18	1/2"

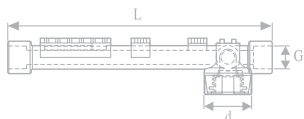

ADJUSTABLE ARMATURE CONNECTOR

CODE	ØD (mm)	d (mm)	L (mm)	G"
7780020127	20	19.5	225	1/2"
7780021127	25	24.5	225	1/2"

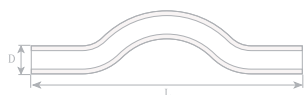

CURVED BRIDGE

CODE	ØD (mm)	L (mm)
7700120020	20	280
7700120025	25	280
7700120032	32	310
7700120040	40	310

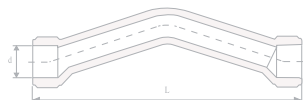

BRIDGE WITH SOCKET

CODE	ØD (mm)	d (mm)	L (mm)
7700130020	20	19.8	160
7700130025	25	24.8	200

PPRC Pipes and Fittings

HALF CURVE WITH SOCKET

CODE	ØD (mm)	d (mm)	L (mm)
7700140020	20	19.8	120.81
7700140025	25	24.8	157.05

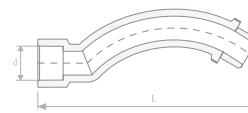

SHORT BRIDGE

CODE	ØD (mm)	d (mm)	L (mm)
7700150020	20	19.8	85
7700150025	25	24.8	97.5
7700150032	32	31.5	130

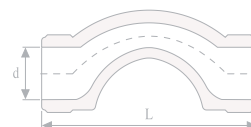

CURVED ELBOW (Female)

CODE	ØD (mm)	d1 (mm)	L (mm)
7711003120	20	19.5	14.5
7711003125	25	24.5	16

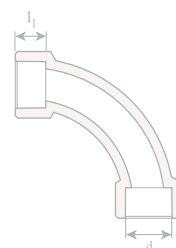

CURVED ELBOW (Male)

CODE	ØD (mm)	d1 (mm)	d2 (mm)	l1 (mm)	l2 (mm)
7711003120	20	19.5	20	14.5	14.5
7711003125	25	24.5	25	16	16

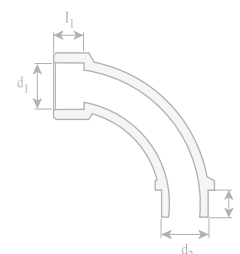

PLUG

CODE	ØD (mm)	L (mm)	AA (mm)	G"
7732000027	20	29	22	1/2"
7732000033	25	23	24	3/4"

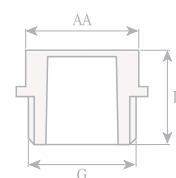

PPRC Pipes and Fittings

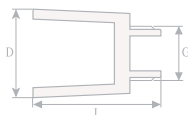

LONG PLUG

CODE	ØD (mm)	d(mm)	L(mm)	G"
7732020020	32.5	49.5	49.5	1/2"

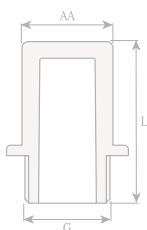

LONG PLUG (Type 2)

CODE	ØD (mm)	d(mm)	AA(mm)	G"
7732010020	20	39	22	1/2"

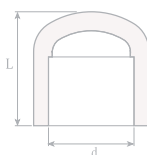

END CAP

CODE	ØD (mm)	d(mm)	l ₁ (mm)	L(mm)
7731000020	20	19.5	14.5	25.8
7731000025	25	24.5	16	31.5
7731000032	32	31.5	18	36
7731000040	40	39.4	20.5	42
7731000050	50	49.4	23.5	47
7731000063	63	62.5	27.5	56.4
7731000075	75	74.2	31	70
7731000090	90	89.2	35.5	80
7731000110	110	109	41.	9
7731000125	125	123.5	46	105
7731000160	160	158.2	58	131

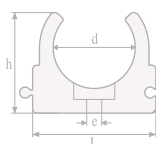

CLAMP

CODE	ØD (mm)	d(mm)	e(mm)	h(mm)	L(mm)
7733000020	20	19	5.5	27.3	30
7733000025	25	24	5.5	31.5	36
7733000032	32	30	5.5	36.7	45
7733000040	40	39	5.5	44.7	54

PPRC Pipes and Fittings

DOUBLE CLAMP

CODE	ØD (mm)	d (mm)	h (mm)	L (mm)
7733000021	20	19.8	29.6	64.4
7733000026	25	24.8	30.7	78.7
7733000034	32	31.5	37.5	87.5

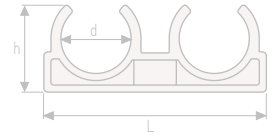

BOILER SET

CODE	Box
7680000100	12 Box / Parcel



Dublex PVC Sewage Pipes and Fittings

Firat Dublex PVC sewage pipes and fittings are used in the villas and multi-story buildings, hospitals, schools, hotels, industrial and sport buildings etc. as they are environment-friendly and cost-effective, maintaining its physical structure up to 60°C, suitable for long-term use, allowing safe and ideal discharge of surface and subsurface sewage.

FIRAT Dublex PVC sewage pipes and fittings are manufactured in the wall thicknesses of the application class BD specified as per the quality standards TS 275-1 EN 1329-1. Thanks to their smooth internal and external surfaces, they do not allow formation of deposit and debris or growth of bacteria and smell.

Manufactured from rigid PVC raw material, FIRAT Dublex PVC waste water pipes and fittings are of flame-retardant construction material class B1 as defined by the DIN 4102 and National Fire Regulations.

FIRAT Dublex PVC-based sewage and fittings are, therefore, fireproof in case of possible fire cases (PP-based materials are inflammable and combustible), preventing spread of fire between the floors. For this reason, they are especially recommended for the multi-storey buildings.

With a wide range of alternatives in sizes, e.g., 50 - 315 mm diameter and 150 - 6000 mm length, FIRAT Dublex waste water pipes and fittings satisfy all kinds of requirements for discharge of sewage discharge. Dublex PVC waste water fittings never allow leakage due to the sealing bearings which are single- cheek, spiked and fully compatible. As they are easy to install and replace, the discharge system is installed quickly and does not require laborious operations such as cutting, bending and adhering.

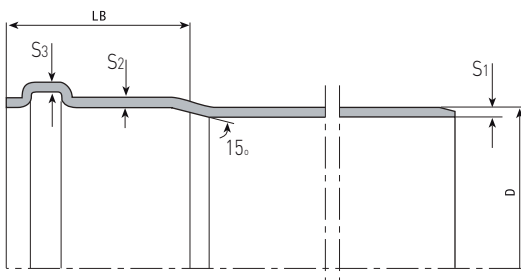

Physical Specifications of Dublex Pipes

Outer Diameter (mm)	S1 (mm)	S2 (mm)	S3 (mm)	LB (mm)	Weight (kg/m)
50	3.0	2.9	2.4	39.3	0.777
75	3.0	2.9	2.4	46.1	1.180
110	3.2	2.9	2.4	56.9	1.880
125	3.2	2.9	2.4	62.8	2.014
160	4.0	3.6	3.0	75.8	3.046
200	4.9	4.4	3.7	89.4	5.240
250	6.2	5.6	4.7	112.6	8.470
315	7.7	6.9	5.8	135.4	13.420

Dublex Waste Water Pipes and Fittings

General Features

- PVC-U Pipes and fittings are used for sewage –discharge in buildings.
- They are manufactured in diameters between Ø 50-315 mm as defined in TS 275-1 EN 1329-1 standard and in various lengths from 15 cm to 6 m with seals.
- The most important feature of PVC-U Pipes and fittings is their non-combustibility. With this feature, spread of a fire between floors in the building is prevented.
- FIRAT Dublex PVC-U Pipes are manufactured as BD class (with thick wall) as defined in TS 275-1 EN 1329-1 standard.
- BD application field code defines applications, including surface and under plaster mounted systems, until building sewage system connection.
- PVC-U Pipes and fittings preserve their physical structure under continuous operating temperature up to 60°C.
- Cornered seal groove and special seal ensures 100% leak-proof performance in leakage test. (0.5 bar 15 min)
- Firatpipe 2,2 mm PVC Sewage Pipes.
- Firatpipe 2,2 mm PVC Sewage Pipes are manufactured in diameters between Ø 50-200 mm and in various lengths from 50 cm to 6 m with seals.
- The most important feature of Firatpipe 2,2 mm PVC Sewage Pipes is their non-combustibility. With this feature, spread of a fire between floors in the building is prevented.
- Firatpipe 2,2 mm PVC Sewage Pipes preserve their physical structure under continuous operating temperature up to 60°C.

- Cornered seal groove and special seal of Firatpipe 2,2 mm PVC Sewage Pipes ensures 100% leak-proof performance in leakage test. (0.5 bar 15 min)

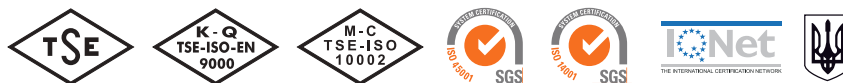

Dublex Waste Water Pipes and Fittings

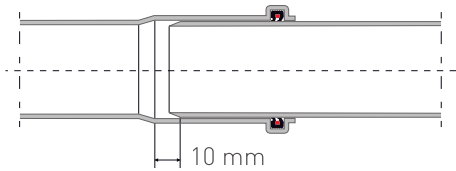
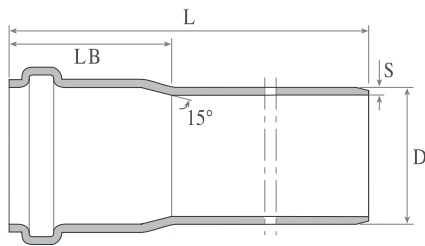

DUBLEX WASTE WATER PIPES		
CODE	ØD (mm)	Length L (mm)
7030050015	50	150
7030050025	50	250
7030050050	50	500
7030050100	50	1000
7030050200	50	2000
7030050300	50	3000
7030050600	50	6000
7030070015	75	150
7030070025	75	250
7030070050	75	500
7030070100	75	1000
7030070200	75	2000
7030070300	75	3000
7030070600	75	6000
7030100015	110	150
7030100025	110	250
7030100050	110	500
7030100100	110	1000
7030100200	110	2000
7030100300	110	3000
7030100600	110	6000
7030125015	125	150
7030125025	125	250
7030125050	125	500
7030125100	125	1000
7030125200	125	2000
7030125300	125	3000
7030125600	125	6000
7030150015	160	150
7030150025	160	250
7030150050	160	500
7030150100	160	1000
7030150200	160	2000
7030150300	160	3000
7030150600	160	6000
7030200015	200	150
7030200025	200	250
7030200050	200	500
7030200100	200	1000
7030200200	200	2000
7030200300	200	3000
7030200600	200	6000
7030250015	250	150
7030250025	250	250
7030250050	250	500
7030250100	250	1000
7030250200	250	2000
7030250300	250	3000
7030250600	250	6000
7030315050	315	500
7030315100	315	1000
7030315200	315	2000
7030315300	315	3000
7030315600	315	6000

Dublex Waste Water Pipes and Fittings

ELBOW (87°)

CODE	ØD (mm)	d1 (mm)	d2 (mm)	S1 (mm)	S2 (mm)	S3 (mm)
7011050087	50	50	50.3	3.0	2.7	2.3
7011075087	75	75	75.4	3.0	2.7	2.3
7011100087	110	110	110.4	3.2	2.9	2.4
7011125087	125	125	125.5	3.2	2.9	2.4
7011150087	160	160	160.5	4.0	3.6	3.0
7011200087	200	200	200.6	4.9	4.4	3.7
7011250087	250	250	250.6	6.2	5.6	4.7
70K0131587	315	315	315.7	7.7	6.9	5.8

K Confection Production

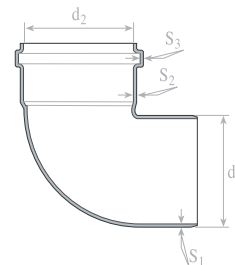

ELBOW (45°)

CODE	ØD (mm)	d1 (mm)	d2 (mm)	S1 (mm)	S2 (mm)	S3 (mm)
7011050045	50	50	50.3	3.0	2.7	2.3
7011070045	75	75	75.4	3.0	2.7	2.3
7011100045	110	110	110.4	3.2	2.9	2.4
7011125045	125	125	125.5	3.2	2.9	2.4
7011160045	160	150	160.5	4.0	3.6	3.0
7011200045	200	200	200.6	4.9	4.4	3.7
7011250045	250	250	250.6	6.2	5.6	4.7
70K0131545	315	315	315.7	7.7	6.9	5.8

K Confection Production

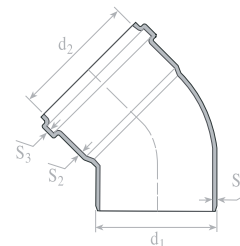

T-PIECE

CODE	ØD (mm)	d1 (mm)	d2 (mm)	d3 (mm)	S1 (mm)	S2 (mm)	S3 (mm)
7014050050	50-50	50	50.3	50.3	3.0	2.7	2.3
7014070050	75-50	75	75.4	75.4	3.0	2.7	2.3
7014070070	75-75	75	75.4	75.4	3.0	2.7	2.3
7014100050	110-50	110	110	110.4	3.2	2.9	2.4
7014100070	110-75	110	110	110.4	3.2	2.9	2.4
7014100100	110-110	110	110	110.4	3.2	2.9	2.4
70K0412505	125-50	125	125	125.5	3.2	2.9	2.4
70K0412507	125-75	125	125	125.5	3.2	2.9	2.4
7014125100	125-110	125	125	125.5	3.2	2.9	2.4
7014125125	125-125	125	125	125.5	3.2	2.9	2.4
70K0415005	160-50	160	160	160.5	4.0	3.6	3.0
70K0415007	160-75	160	160	160.5	4.0	3.6	3.0
7014150100	160-110	160	160	160.5	4.0	3.6	3.0
7014150125	160-125	160	160	160.5	4.0	3.6	3.0
7014150150	160-160	160	160	160.5	4.0	3.6	3.0
70K0420010	200-110	200	200	200.7	4.9	4.4	3.7
70K0420012	200-125	200	200	200.7	4.9	4.4	3.7
70K0420015	200-160	200	200	200.7	4.9	4.4	3.7
7014200200	200-200	200	200	200.7	4.9	4.4	3.7
70K0425015	250-160	250	250	250.6	6.2	5.6	4.7
70K0425020	250-200	250	250	250.6	6.2	5.6	4.7
7014250250	250-250	250	250	250.6	6.2	5.6	4.7
70K0431510	315-100	315	315.7	119.4	7.7	6.9	2.4
70K0431512	315-125	315	315.7	125.5	7.7	6.9	2.4
70K0431515	315-160	315	315.7	160.5	7.7	6.9	3.0
70K0431520	315-200	315	315.7	200.7	7.7	6.9	4.7
70K0431531	315-315	315	315.7	315.7	7.7	6.9	5.8

K Confection Production

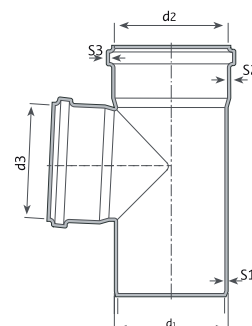

Dublex Waste Water Pipes and Fittings

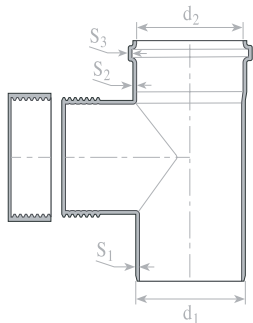

ACCESS T-PIECE

CODE	ØD (mm)	d ₂ (mm)	S ₁ (mm)	S ₂ (mm)	S ₃ (mm)	
7016001070	75	50	50.3	3.0	2.7	2.3
7016001100	110	75	75.4	3.0	2.7	2.3
7016001125	125	110.4	110.4	3.2	2.9	2.4
7016001150	160	125.4	125.5	3.2	2.9	2.4
7016001200	200	160.5	160.5	4.0	3.6	3.0
70K0625000	250	200.6	200.6	4.9	4.4	3.7
70K0631500	315	250.6	250.6	6.2	5.6	4.7

K Confection Production

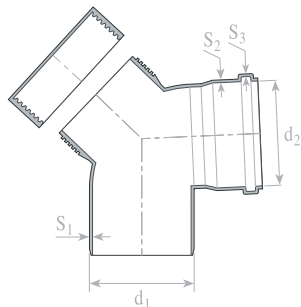

CLEAN OUT ELBOW

CODE	ØD (mm)	d ₂ (mm)	S ₁ (mm)	S ₂ (mm)	S ₃ (mm)
7016001110	110	110.4	3.2	2.9	2.9

SINGLE BRANCH (45°)

CODE	ØD (mm)	d ₁ (mm)	d ₂ (mm)	d ₃ (mm)	S ₁ (mm)	S ₂ (mm)	S ₃ (mm)
7013050050	50-50	50	50.3	50.3	3.0	2.7	2.3
7013070050	75-50	75	75.4	50.3	3.0	2.7	2.3
7013070070	75-75	75	75.4	75.4	3.0	2.7	2.3
7013100050	110-50	110	110.4	50.3	3.2	2.9	2.4
7013100070	110-75	110	110.4	75.4	3.2	2.9	2.4
7013100100	110-110	110	110.4	110.4	3.2	2.9	2.4
7013125050	125-50	125	125.5	50.3	3.2	2.9	2.4
7013125070	125-75	125	125.5	75.4	3.2	2.9	2.4
7013125100	125-110	125	125.5	110.4	3.2	2.9	2.4
7013125125	125-125	125	125.5	125.5	3.2	2.9	2.4
70K0315005	160-50	160	160.6	50.4	4.0	3.6	3.0
70K0315007	160-75	160	160.6	75.4	4.0	3.6	3.0
7013150100	160-110	160	160.6	110.4	4.0	3.6	3.0
7013150125	160-125	160	160.5	125.5	4.0	3.6	3.0
7013150150	160-160	160	160.5	160.5	4.0	3.6	3.0
7013200100	200-110	200	200.7	110.5	4.9	4.4	3.7
70K0320012	200-125	200	200.7	125.5	4.9	4.4	3.7
7013200150	200-160	200	200.7	160.6	4.9	4.4	3.7
7013200200	200-200	200	200.7	200.7	4.9	4.4	3.7
70K0325010	250-100	250	200.7	110.5	6.2	5.6	4.7
70K0325012	250-125	250	250.6	125.5	6.2	5.6	4.7
70K0325015	250-150	250	250.6	160.6	6.2	5.6	4.7
70K0325020	250-200	250	250.6	200.7	6.2	5.6	4.7
7013250250	250-250	250	250.6	250.6	6.2	5.6	4.7
70K0331520	315-200	315	315.7	200.7	7.7	6.9	4.7
70K0331525	315-250	315	315.7	250.6	7.7	6.9	4.7
70K0331531	315-315	315	315.7	315.7	7.7	6.9	4.7

K Confection Production

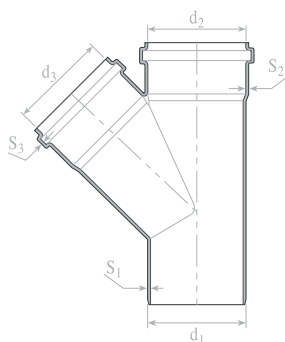

Dublex Waste Water Pipes and Fittings

REDUCER

CODE	ØD (mm)	d1 (mm)	d2 (mm)	S1 (mm)	S2 (mm)	S3 (mm)
7012070050	75-50	75	50.3	3.3	2.7	2.3
7012100050	110-50	110	50.3	3.2	2.9	2.4
7012100070	110-75	110	75.4	3.2	2.9	2.4
7012125070	125-75	125	75.4	3.2	2.9	2.4
7012125100	125-110	125	110.4	3.2	2.9	2.4
7012150100	160-110	160	110.4	4.0	3.6	3.0
7012150125	160-125	160	125.5	4.0	3.6	3.0
7012200100	200-110	200	110.4	4.9	4.4	3.7
70K0220012	200-125	200	125.5	4.9	4.4	3.7
7012200150	200-160	200	160.5	4.9	4.4	3.7
7012250200	250-200	250	200.6	6.2	4.4	3.7
70K0231510	315-110	315	110.4	6.2	4.4	3.7

K Confection Production

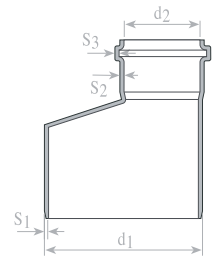

CROSS-T

CODE	ØD (mm)	d-d1 (mm)	d2-d3 (mm)	S1 (mm)	S2 (mm)	S3 (mm)
7014500100	110	110	110.4	3.2	2.9	2.4

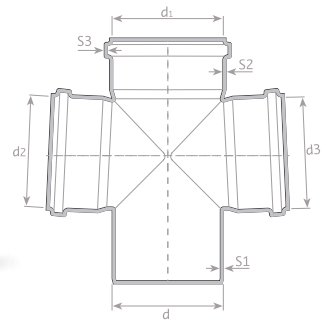

DOUBLE BRANCH (45°-45°)

CODE	ØD (mm)	d1 (mm)	d2 (mm)	d3 (mm)	S1 (mm)	S2 (mm)	S3 (mm)
7015050050	50-50	50	50.3	50.3	3.0	2.7	2.3
7015070050	75-50	75	75.4	50.3	3.0	2.7	2.3
7015070070	75-75	75	75.4	75.4	3.0	2.7	2.3
7015100050	110-50	110	110.4	50.3	3.2	2.9	2.4
7015100070	110-75	110	110.4	75.4	3.2	2.9	2.4
7015100100	110-110	110	110.4	110.4	3.2	2.9	2.4
70K0512505	125-50	125	125.5	50.3	3.2	2.9	2.4
70K0512507	125-75	125	125.5	75.4	3.2	2.9	2.4
7015125100	125-110	125	125.5	110.4	3.2	2.9	2.4
70K0512512	125-125	125	125.5	125.5	3.2	2.9	2.4
70K0515005	160-50	160	160.6	50.4	4.0	3.6	3.0
70K0515007	160-75	160	160.6	75.4	4.0	3.6	3.0
70K0515010	160-110	160	160.6	110.4	4.0	3.6	3.0
70K0515012	160-125	160	160.5	125.5	4.0	3.6	3.0
70K0515015	160-160	160	160.5	160.5	4.0	3.6	3.0
70K0520010	200-110	200	200.7	110.5	4.9	4.4	3.7
70K0520012	200-125	200	200.7	125.5	4.9	4.4	3.7
70K0520015	200-160	200	200.7	160.6	4.9	4.4	3.7
70K0520020	200-200	200	200.6	200.6	4.9	4.4	3.7
70K0525025	250-250	250	250.6	250.6	6.2	5.6	4.7
70K0531520	315-200	315	315	200.6	6.2	5.6	4.7

K Confection Production

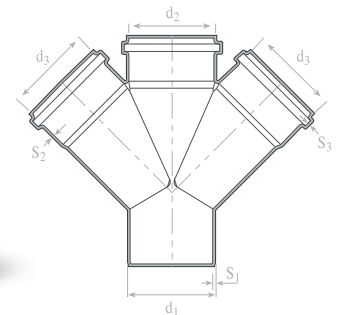

Dublex Waste Water Pipes and Fittings

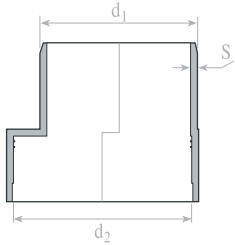

WC CONNECTOR

CODE	ØD (mm)	d1 (mm)	d2 (mm)	S3 (mm)
7066002100	110	110	131.0	3.2

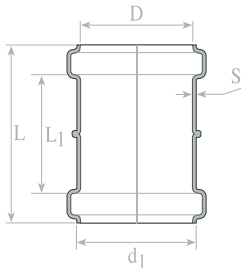

SLIDING SOCKET

CODE	ØD (mm)	D (mm)	d1 (mm)	S (mm)	L (mm)	L1 (mm)
7066007050	50	50.3	59.6	3.0	84	58.4
7066007070	75	75.4	84.5	3.0	96	70.4
7066007100	110	110.4	120.6	3.2	130	98.8
7066007125	125	125.4	137.5	3.2	160	112.4
7066007150	160	160.5	174.3	4.0	170	125.0

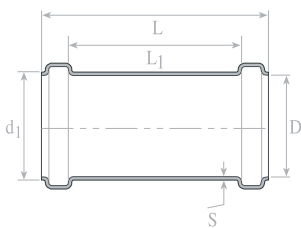

SOCKET

CODE	ØD (mm)	D (mm)	d1 (mm)	S (mm)	L (mm)	L1 (mm)
7016007125	125	125.4	137.5	3.2	480	420
7016007160	160	160.5	174.3	4.0	480	420
7016007200	200	200.6	216.7	4.9	760	700

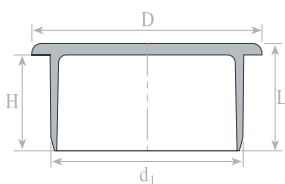

PLUG

CODE	ØD (mm)	D (mm)	d1 (mm)	L (mm)	H (mm)
7016004050	50	60	50	28	25
7016004070	75	85	75	34	30
7016004100	110	120	110	38	34
7016004125	125	138	125	40	45
7016004150	160	173	160	60	55
7016004200	200	214	200	71	65

Dublex Waste Water Pipes and Fittings

S SIPHON

CODE	ØD (mm)	d1 (mm)	d2 (mm)	a (mm)	b (mm)	S (mm)
7016002145	75/45°	75	97	150	202	3.0
7016002175	75/87°	75	97	150	195	3.0
7016002100	100/87°	110	140	212	290	3.2
7016002145	110/45°	110	140	212	263	3.2

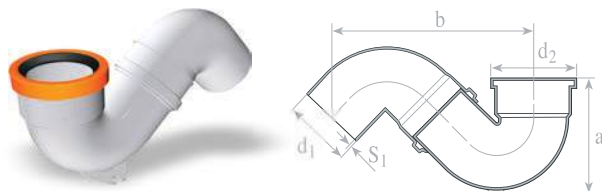

S SIPHON WITH MUFF

CODE	ØD (mm)	d1 (mm)	d2 (mm)	a (mm)	b (mm)	S (mm)
7017000100	110	110	126	176	167	3.2
7017000145	110/45°	110	126	178	268	3.2

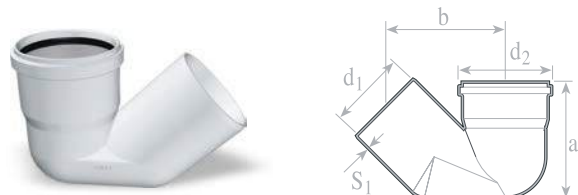

AIR HOLE PIPE

CODE	ØD (mm)	d1 (mm)	S (mm)
70K0707000	75	75	3.2
70K0710000	110	110	4.0

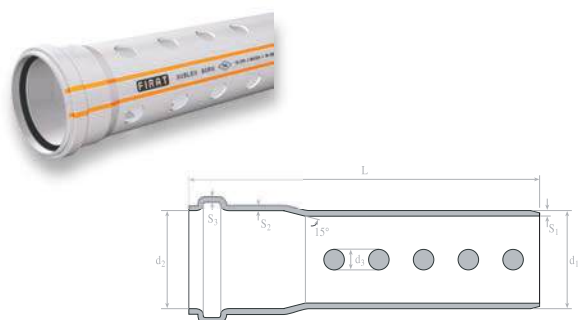

REPAIR SOCKET

CODE	ØD (mm)	D (mm)	d1 (mm)	S (mm)	L (mm)	L1 (mm)
7016007125	125	125.4	137.5	3.2	480	420
7016007160	160	160.5	174.3	4.0	480	420
7016007200	200	200.6	216.7	4.9	760	700

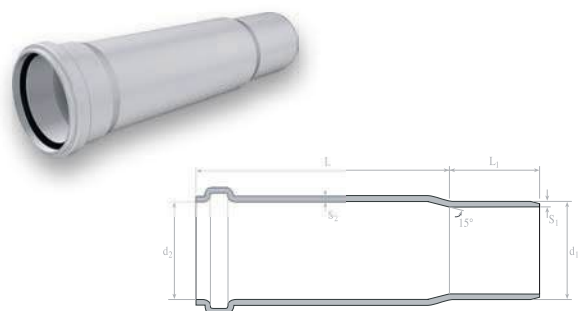

Dublex Waste Water Pipes and Fittings

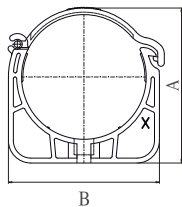

BRACELETS

CODE	ØD (mm)	A(mm)	B(mm)
7016005050	50	78.30	57.60
7016005070	75	118.20	83.60
7016005100	110	152.55	120.00
7016005125	125	159.50	167.65
7016005150	160	207.60	207.45



ADAPTING SEAL

CODE	ØD (mm)
7066005050	50



WASTE WATER SEAL

CODE	ØD (mm)
2001001050	50
2001001070	75
2001001100	110
2001001125	125
2001001150	160
2001001200	200
2001001250	250



WASTE WATER O'RING SEAL

CODE	ØD (mm)
7800090050	50
7800090070	75
7800090100	110

Gediz Pipes

General features

- Gediz Pipes are produced with diameters from Ø 50-200 mm and in various lengths from 50 cm to 6 m with seals.
- The most important feature of Gediz Pipes is non flammability This feature prevents spread fires between floors in the building
- Gediz Pipes preserve their physical structure under continuous working temperature up to 60°C
- Cornered seal groove and special seal ensures 100% leak-proof performance in leakage test (0.5 bar 15 min).



GEDIZ PIPES

CODE	ØD (mm)	Length L (mm)
7026050050	50	500
7026050100	50	1000
7026050200	50	2000
7026050300	50	3000
7026050600	50	6000
7026070050	75	500
7026070100	75	1000
7026070200	75	2000
7026070300	75	3000
7026070600	75	6000
7026100050	110	500
7026100100	110	1000
7026100200	110	2000
7026100300	110	3000
7026100600	110	6000
7026125050	125	500
7026125100	125	1000
7026125200	125	2000
7026125300	125	3000
7026125600	125	6000
7026150050	160	500
7026150100	160	1000
7026150200	160	2000
7026150300	160	3000
7026150600	160	6000
7026200050	200	500
7026200100	200	1000
7026200200	200	2000
7026200300	200	3000
7026200600	200	6000

Physical Specifications of Gediz Pipes

Outer Diameter (mm)	S1 (mm)	S2 (mm)	S3 (mm)	LB	Weight (kg/m)
50	1.8	1.7	1.2	39.3	0.470
75	1.8	1.7	1.2	46.1	0.690
110	2.2	1.9	1.6	56.9	1.240
125	2.5	1.9	1.9	62.8	1.560
160	3.2	2.8	2.2	75.8	2.753
200	3.9	3.4	2.7	89.4	4.260

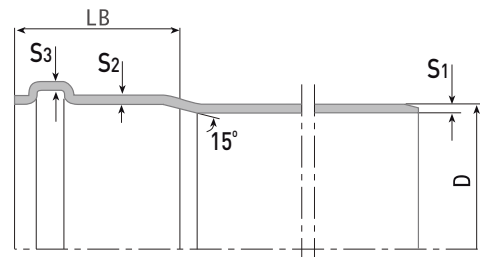

Residence Silent Pipes and Fittings

General Definition

Fluids passing through the pipe at different flow velocities cause vibrations while hitting the pipe walls and obstacles in the pipe and make sounds that cause disturbances in living spaces. Modern developments in the construction sector have accelerated housing delivery times.

Construction companies needed quieter piping to reduce the additional labour costs and time costs for installation of insulation.

Silent Pipe Usage Areas

Due to its characteristics of being ecological, economic and soundproof Residence Pipe and Fittings is a preferable choice to be used in villas and multi-storey residences, hospitals, schools, hotels and industrial or sportive structures, etc. Silent pipes ensure for the sewage from the foundations and interior structures of buildings to be drained in an ideal and safe way without any leakage for long terms use (50 years).

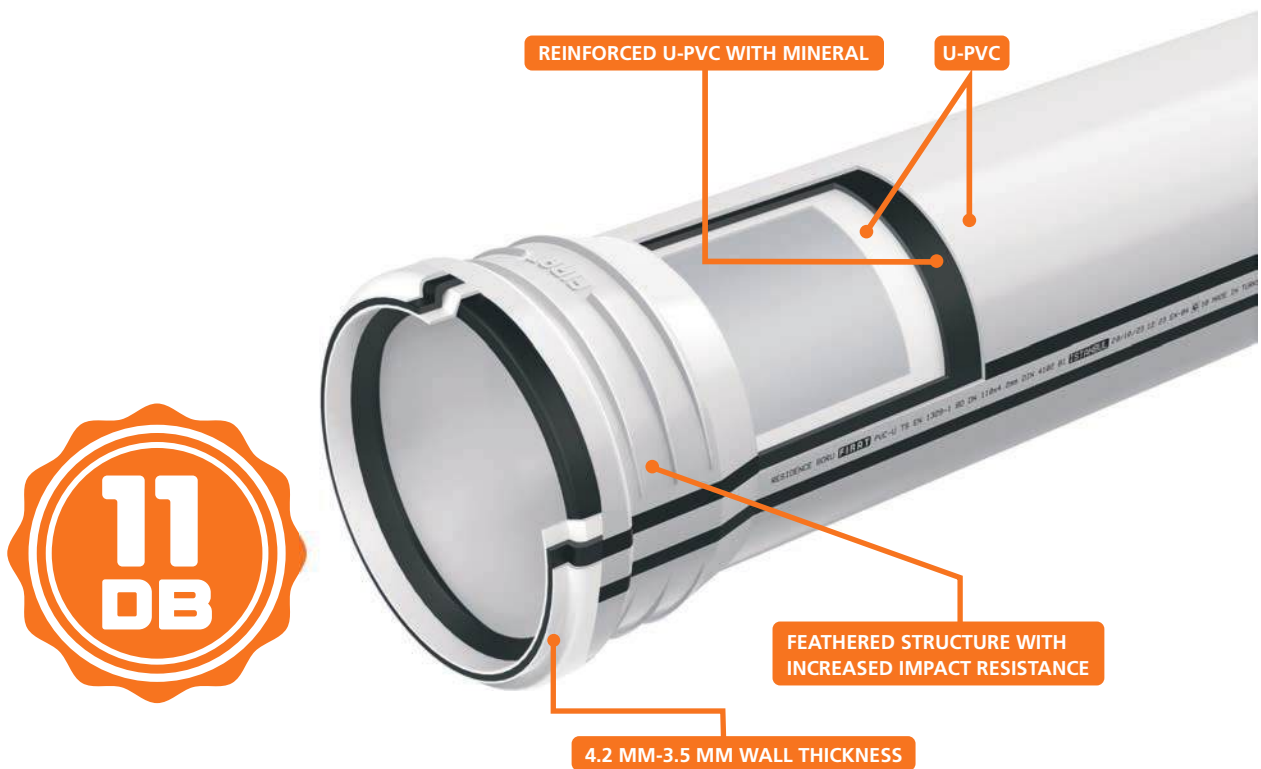

Open Elbow (45°)



Close Elbow (87°)



TE Branch



Single Branch (45°)



*B Class (TS EN 13501-1'e compliant)

Residence Pipe Diameter And Wall Thicknesses 3.5 mm

Pipe Outer Diameter (mm)	50	75	110	125	160
Wall Thickness (mm)	3.0	3.0	3.5	3.6	4.3

Residence Pipe Diameter And Wall Thicknesses 4.2 mm

Pipe Outer Diameter (mm)	50	75	110	125	160	200
Wall Thickness (mm)	3.6	3.6	4.2	4.2	5.0	5.0

Residence Silent Pipes and Fittings

Material Specifications

Residence Pipes And Fittings are produced in 3 layers with a mixture of U-PVC and vinyl-copolymer (FRvinyflex) raw materials.

The inner Layer: is made of U-PVC with smooth inner surface.

The middle Layer: FRvinyflex® is a mineral-based additive developed in Firat R&D laboratories which provides Residence pipes and fittings with soundproof features.

The outer Layer: It is made of U-PVC which protects the pipe against external impacts.

Seal

The seal made from EPDM paste conforming to TS EN 681-1 standard and thanks to it unidirectional and special outside shape it provide 100% impermeability.



FRvinyflex

It is produced as a 3-layer mixture of U-PVC and vinyl-copolymer (FRvinyflex) raw materials.



Look

Residence Pipe and Fittings are produced in a grey colour. Feathered structure with increased impact resistance have been added to the muff sections.



Acoustic Performance Test of Silent Pipe Wastewater System (With Bracelets)

Sample of test: Wastewater System " FIRAT, RESIDENCE PIPE, PVC-U, 110x4.2, 11/02/18 (Manufacture Company: Firat Plastik) Wastewater System consist of Firat acoustic braceletes of pipe, straight plastic pipes and fittings.		Flow rate							
		New Residence (4,2 mm)				New Residence (3,5 mm)			
		0.5	1.0	2.0	4.0	0.5	1.0	2.0	4.0
For basement test room, according to EN 14366; Air-borne sound pressure level La. A(dB(A))	UG front	43	47	49	52	43	47	49	52
For basement test room, according to EN 14366; Structure-borne sound characteristic level Lsc. A (dB(A))	UG back	<10	<10	<10	11	<10	<10	<10	11
For basement test room, according to DIN 4109; Plumbing sound level LAFeq.n (dB (A))	UG front	43	47	49	52	43	47	49	52
	UG back	<10	<10	<10	15	<10	<10	<10	15
For basement test room, according to VDI 4100; Plumbing sound level LAFeq.nt (dB (A))	UG front	40	44	47	50	40	45	47	50
	UG back	<10	<10	<10	11	<10	<10	<10	11

Residence Silent Pipes and Fittings

Fraunhofer Institut Für Bauphysik

According to the test report "Determination of Acoustic Performance in Laboratory Conditions of Waste Water Installation Systems" by Fraunhofer IBP Institute of Building Physics, the sound value of Residence Pipe and Fittings was tested at 11 dB.

Residence Pipe Systems are soundproof.

According to the results of the sound level measurement test done at the Fraunhofer Institut Bauphysik (Germany) Residence Pipes and Fittings meet all national and international standard requirements.

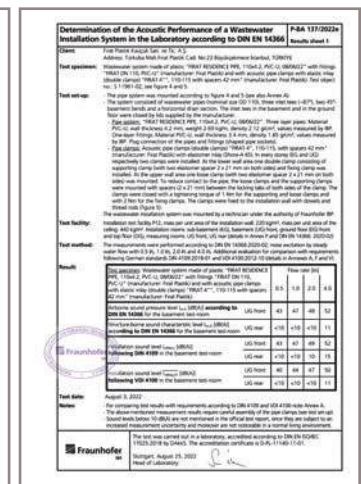
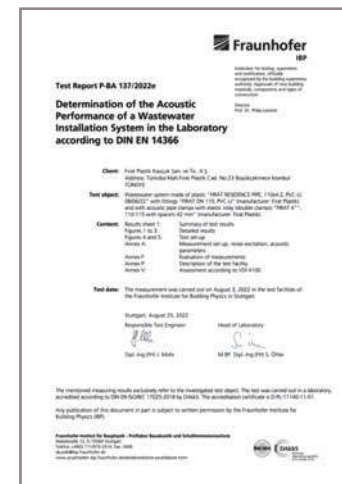
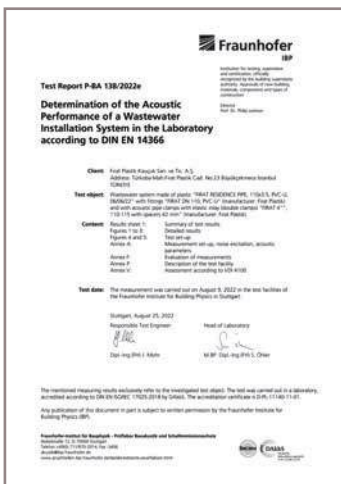

New Residence Silent Power Pipes and Fittings Test (Clamp System)

Flow Rate (liters per second)	0.5	1.0	2.0	4.0
Characteristic Sound Level - Decibels (dB(A))	<10	<10	<10	11



Residence Silent Pipes and Fittings

Standards And Test Reports For Residence Pipe And Fittings

Meets the mechanical and physical requirements of BD class of the TS EN 1329-1 standard. BD Implementation class covers in-building and surface application areas, in-building under the surface application areas, and application areas up to the sewer connection of the building.

Residence Pipes and Fittings are of the non-flammable class within the scope of the "Regulation on Protection of Buildings from Fire" as stated in the 2007/12937 decision of the Ministry of Public Works and Settlement.

As a result of the fire response performance test carried out at UL (Underwriters Laboratories), an independent US-based product safety certification agency, Residence Pipes and Fittings are categorized as V-0 NON-COMBUSTIBILITY class.

TSE TEST AND CALIBRATION CENTRE EXAMINATION AND TEST REPORT Fire response classification of Residence Pipe and Fittings was found as B S2 D0 according to TS EN 13501-1 + A1: 2013-04 Fire Response Classification of Construction Products And Building Elements. Fire Class B, Smoke Formation S2, Flaming Droplets D0.

Sound Measurement - Response to Fire (Test Reports)
 Fire response performance classes for building materials other than flooring Equivalences of the fire response classes of building materials stated by the relevant eu commission decisions with the flammability classes of building materials specified in the regulation on the protection of buildings from fire with decision number 2002/4390

Fudel Accredited Laboratory



Turkey's First Accredited Pipes Laboratory

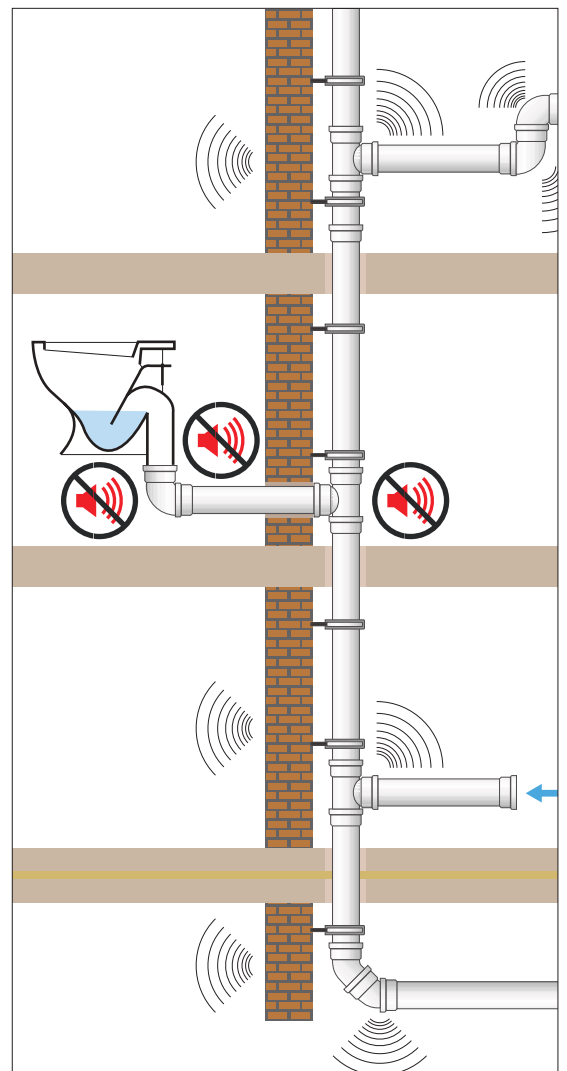

Residence Silent Pipes and Fittings

New Residence (4,2 mm)
Residence (3,5 mm)



***B1 Class (DIN 4102 compliant)**

Sound Measurement - Response to Fire (Test Reports)

Fire response performance classes for building materials other than flooring.

Equivalences of the fire response classes of building materials stated by the relevant eu commission decisions with the flammability classes of building materials specified in the regulation on the protection of buildings from fire with decision number 2002/4390

Inflammability of the Material	Europe Classification (According to TS EN 13501-1)	
Non Combustible	A1	
Not Easily Combustible	A2 - S1, d0	
	B-S1, d0	
	C-S1, d0	
	A2 - S2, d0	
	A2 - S3, d0	
	B - S2, d0	
	B - S3, d0	
	C - S2, d0	
	C - S3, d0	
	Non-Flammable	A2 - S1, d1
		A2 - S1, d2
		B - S1, d1
		B - S1, d2
		C - S1, d1
C - S1, d2		
A2 - S3, d2		
B - S3, d2		
C - S3, d2		
D - S1, d0		
D - S2, d0		
D - S3, d0		
E		
Normal Flammable	D - S1, d1	
	D - S2, d1	
	D - S3, d1	
	D - S1 d2	
	D - S2 d2	
	D - S3 d2	
	E - d2	
Easily Flammable	F	



Residence Silent Pipes and Fittings

Physical And Chemical Properties

Residence Pipes and Fittings meet the mechanical and chemical properties mentioned in the TS EN 1329-1 standard.

Serial	Test	Test Method	Test Period	Test Temperature	Required Performance
1	Impact Resistance	TS EN ISO 3127	-	0°C	Max. 10 %
2	Vicat Softening Temperature	TS EN ISO 2507-1	-	100°C	Min. 79°C
3	Lengthwise Dimensional Change	TS EN ISO 2505	30 Minutes	150°C	Max. 5%
4	Resistance to Dichloromethane	TS EN ISO 9852	30 Minutes	15°C	Any break down must not be observed.
5	Temperature Resistance Test	TS EN ISO 580	30 Minutes	150°C	Any break down must not be observed.
6	Leakage Test (0,5 bar)	TS EN ISO 13254	15 Minutes	23°C	Any leakage must not be observed.



Residence Silent Pipes and Fittings

NEW RESIDENCE SILENT PIPES

CODE 4.2 MM Wall Thickness (mm)	CODE 3.5 MM Wall Thickness (mm)	ØD(mm)	Length L (mm)
7052050015	7054050015	50	150
7052050025	7054050025	50	250
7052050050	7054050050	50	500
7052050100	7054050100	50	1000
7052050200	7054050200	50	2000
7052050300	7054050300	50	3000
7052050600	7054050600	50	6000
7052070015	7054070015	75	150
7052070025	7054070025	75	250
7052070050	7054070050	75	500
7052070100	7054070100	75	1000
7052070200	7054070200	75	2000
7052070300	7054070300	75	3000
7052070600	7054070600	75	6000
7052100015	7054100015	110	150
7052100025	7054100025	110	250
7052100050	7054100050	110	500
7052100100	7054100100	110	1000
7052100200	7054100200	110	2000
7052100300	7054100300	110	3000
7052100600	7054100600	110	6000
7052125015	7054125015	125	150
7052125025	7054125025	125	250
7052125050	7054125050	125	500
7052125100	7054125100	125	1000
7052125200	7054125200	125	2000
7052125300	7054125300	125	3000
7052125600	7054125600	125	6000
7052150015	7054150015	160	150
7052150025	7054150025	160	250
7052150050	7054150050	160	500
7052150100	7054150100	160	1000
7052150200	7054150200	160	2000
7052150300	7054150300	160	3000
7052150600	7054150600	160	6000
7052200050	-	200	500
7052200100	-	200	1000
7052200200	-	200	2000
7052200300	-	200	3000

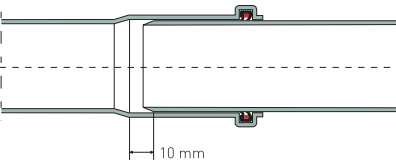
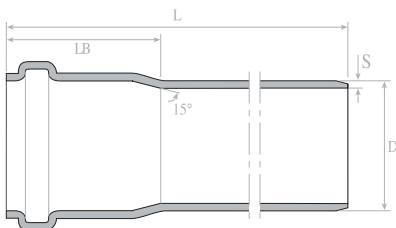

T-PIECE

CODE	ØD (mm)	d1(mm)	d2(mm)	d3 (mm)
7074050050	50-50	50	50.3	50.3
7074070050	75-50	75	75.4	50.3
7074070070	75-75	75	75.4	75.4
7074100050	110-50	110	110.4	50.3
7074100070	110-75	110	110.4	75.4
7074100100	110-110	110	110.4	110.4
7074125100	125-110	125	125.5	110.4
7074125125	125-125	125	125.5	125.5
7074150100	160-110	160	160.6	110.4
7074150125	160-125	160	160.5	125.5
7074150150	160-160	160	160.5	160.5

Residence Silent Pipes and Fittings

ELBOW (45°)

CODE	ØD (mm)	d1 (mm)	d2 (mm)
7071050045	50	50	50.3
7071070045	75	75	75.4
7071100045	110	110	110.4
7071125045	125	125	125.5
7071150045	160	160	160.5
7071200045	200	200	200.6

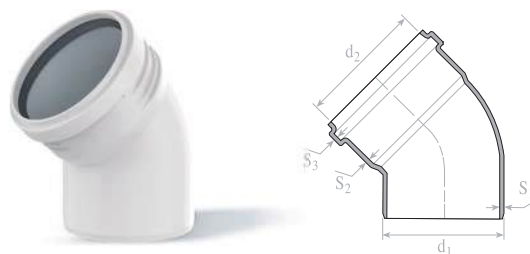

ELBOW (87°)

CODE	ØD (mm)	d1 (mm)	d2 (mm)
7071050087	50	50	50.3
7071070087	75	75	75.4
7071100087	110	110	110.4
7071125087	125	125	125.5
7071150087	160	160	160.5
7071200087	200	200	200.6

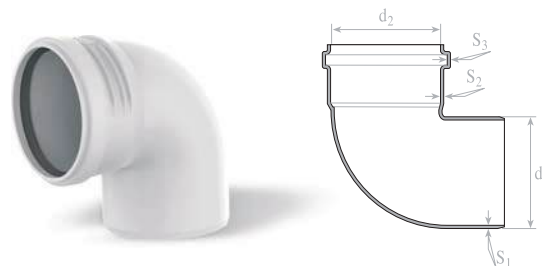

REDUCER

CODE	ØD (mm)	d1 (mm)	d2 (mm)
7072070050	75-50	75	50.3
7072100050	110-50	110	50.3
7072100070	110-75	110	75.4
7072125070	125-75	125	75.4
7072125100	125-110	125	110.4
7072150100	160-110	160	110.4
7072150125	160-125	160	125.5
7072150125	200-125	200	125.5

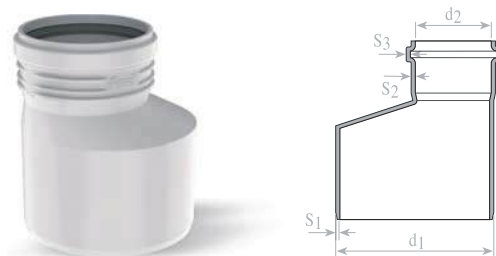

ACCESS T-PIECE

CODE	ØD (mm)	d2 (mm)
7076001070	75	75.4
7076001100	110	110.4
7076001125	125	125.5
7076001150	160	160.5

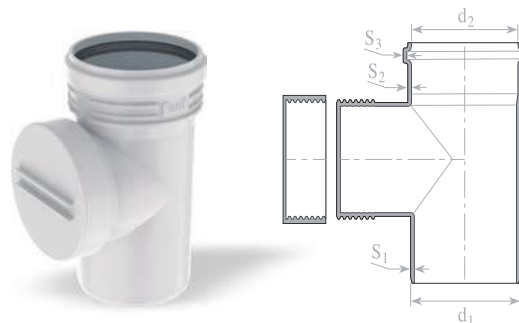

Residence Silent Pipes and Fittings

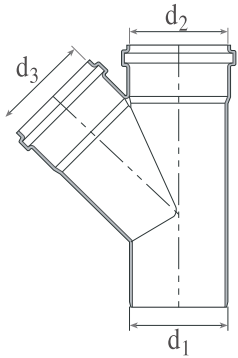

SINGLE BRANCH (45°)

CODE	ØD (mm)	d1 (mm)	d2 (mm)	d3 (mm)
7073050050	50-50	50	50.3	50.3
7073070050	75-50	75	75.4	50.3
7073070070	75-75	75	75.4	75.4
7073100050	110-50	110	110.4	50.3
7073100070	110-75	110	110.4	75.4
7073100100	110-110	110	110.4	110.4
7073125050	125-50	125	125.5	50.3
7073125070	125-75	125	125.5	75.4
7073125100	125-110	125	125.5	110.4
7073125125	125-125	125	125.5	125.5
7073150100	160-110	160	160.6	110.4
7073150125	160-125	160	160.5	125.5
7073150150	160-160	160	160.5	160.5
7073200100	200-110	200	200.7	110.4
70K6320012	200-125	200	200.7	125.5
7073200150	200-160	200	200.7	160.6
7073200200	200-200	200	200.7	160.6

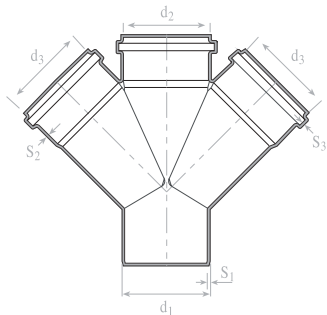

DOUBLE BRANCH (45°-45°)

CODE	ØD (mm)	d1 (mm)	d2 (mm)	d3 (mm)
7075050050	50-50	50	50.3	50.3
7075070050	75-50	75	75.4	50.3
7075070070	75-75	75	75.4	75.4
7075100050	110-50	110	110.4	50.3
7075100070	110-75	110	110.4	75.4
7075100100	110-110	110	110.4	110.4
7075125100	125-110	125	125.5	110.4

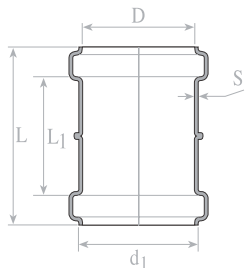

SLIDING SOCKET

CODE	ØD (mm)	D (mm)	d1 (mm)	L (mm)	L1 (mm)
7076007050	50	50.3	59.6	84	58.4
7076007070	75	75.4	84.5	96	70.4
7076007100	110	110.4	120.6	130	98.8
7076007125	125	125.4	137.5	160	112.4
7076007150	160	160.5	174.3	170	125.0

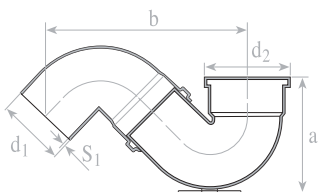

SSIPHON

CODE	ØD (mm)	d1 (mm)	d2 (mm)	a (mm)	b (mm)
7076003100	110/87°	110	140	212	263

Residence Silent Pipes and Fittings

PLUG

CODE	ØD (mm)	D (mm)	d1 (mm)	L (mm)	H (mm)
7076004050	50	60	50	28	25
7076004070	75	85	75	34	30
7076004100	110	120	110	38	34
7076004125	125	138	125	40	45
7076004150	160	173	160	60	55

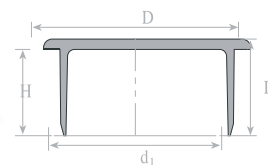

SILENT CLAMP (Vertical/ With Bolt Nut)

CODE	ØD (mm)	PACKAGE QUANTITY
8171050050	50	50 Adet / Box
8171050075	70	30 Adet / Box
8171050110	100	16 Adet / Box
8171050125	125	12 Adet / Box
8171050160	160	10 Adet / Box
8171050200	200	6 Adet / Box



SILENT CLAMP (Horizontal / With Bolt Nut)

CODE	ØD (mm)	PACKAGE QUANTITY
8171055050	50	25 Adet / Box
8171055075	70	15 Adet / Box
8171055110	100	8 Adet / Box
8171055125	125	6 Adet / Box
8171055160	160	5 Adet / Box
8171055200	200	3 Adet / Box



SILENT CLAMP (Acoustick)

CODE	ØD (mm)	PACKAGE QUANTITY
8171060050	50	50 Adet / Box
8171060075	70	30 Adet / Box
8171060110	100	16 Adet / Box
8171060125	125	12 Adet / Box
8171060160	160	10 Adet / Box
8171060200	200	8 Adet / Box



Rain Gutters And Fittings

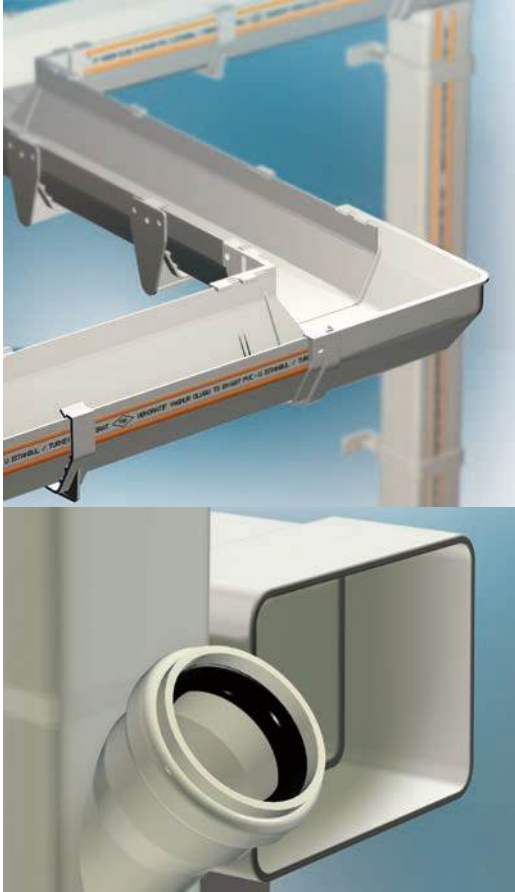

Designed and manufactured in two different types as Decorative and Corner Shaped (150) pursuant to TS EN 607 standard, Firat Gutters and Fittings offer time, labor and cost advantages to the users with their standardized technical features, excellent gutter profiles, quick and simple installation and guaranteed function.

Manufactured with advanced technology upon determining precipitation quantity and the required section diameters accordingly, with the tests during design phase, Firat Gutters and Fittings constitute a rain water discharge system which operates well, is highly functional and has an aesthetic appearance.

Advantages of PVC Gutters and Fittings

- Easy, quick, problem-free and safe installation with perfectly compatible fittings.
- Ensures 100% leak-proof with specially designed seals.
- Has dimensional functionality and a rich variety.
- It is resistant to corrosion, fading and is stainless.
- Functions perfectly even under hot and cold weather conditions.
- Produced using the latest technology.
- Suitable for all facade constructions and can be utilized for any roof and gutter types.
- It has a system structure which enables problem-free intervention every time.
- It is highly efficient with its economical and maintenance-free lifespan.
- They have high rain water conveying capacity.
- It can convey rain water even on very slight slopes.

Pvc Decorative Rain Gutter And Fittings

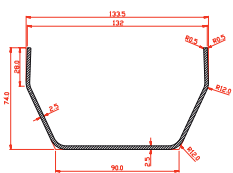

DECORATIVE RAIN GUTTER

CODE	L(m)
7040078400	4

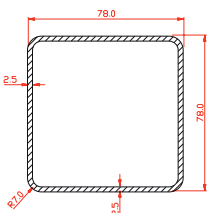

DOWN PIPE 125/3000 (Rectangle)

CODE	L(m)
7041078300	3

PVC Decorative Rain Gutter And Fittings

SOCKET

CODE

7042100006

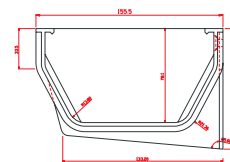

ELBOW (90°)

CODE

7042100007

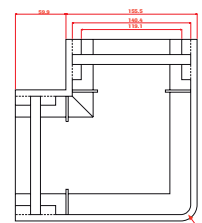

T CONNECTION (Rectangle)

CODE

7042100008

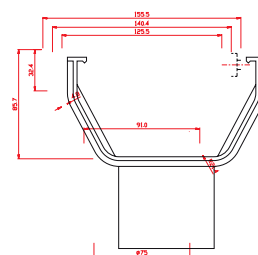

T CONNECTION (Ø70 / Round)

CODE

7042100009

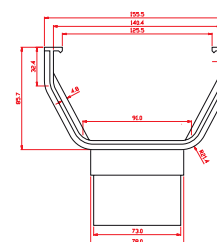

DOWN PIPE SOCKET

CODE

7042100012

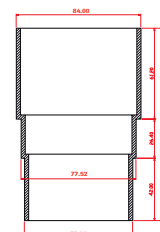

PVC Corner Shaped Rain Gutter And Fittings

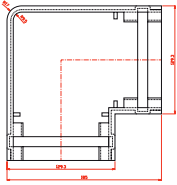

ELBOW (90° Internal and External Corners)

CODE
7042100015

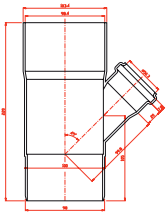

SINGLE BRANCH (45°)

CODE
7042140007

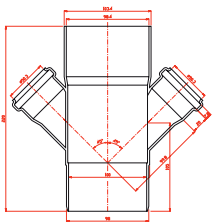

DOUBLE BRANCH (45°-45°)*

CODE
70K1015005

* Fabricated

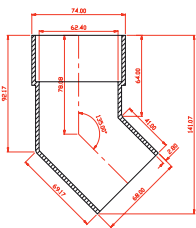

DOWN ELBOW (45°)

CODE
7042140006

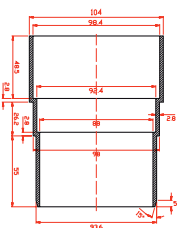

DOWN PIPE SOCKET

CODE
7042140008

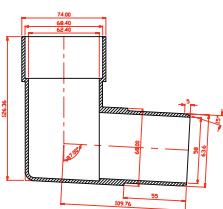

DOWN ELBOW (90°)

CODE
7042140012

PVC Corner Shaped Rain Gutter And Fittings

DOWN PIPE REDUCER(150-110)

CODE

7042140016

7042140015

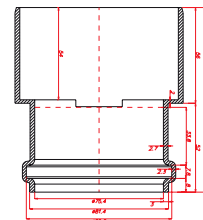

DOWN PIPE REDUCER(150-70)

CODE

7042140017

7042140014

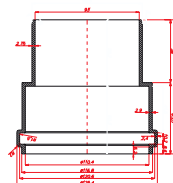

GUTTER END CAP

CODE

7042140005

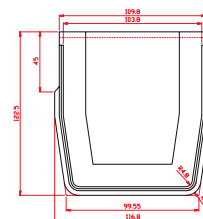

RAIN GUTTER BRACELET

CODE

7042140011

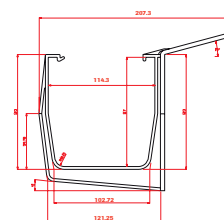

DOWN PIPE BRACELET

CODE

7042140009

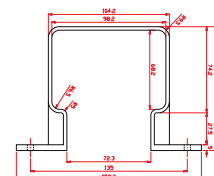

DOWN PIPE BRACELET WITH LOCK

CODE

7042140013

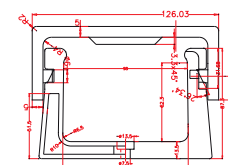

Polyethylene Pipes



Polyethylene Pipes provide high performance and economical solutions in drinking and potable water networks.

- PE Pipes have high flexibility. In this way, their installation is easy. Elongation at break is minimum 350%.
- They are not affected by underground movements and have no breaking properties.
- Impact resistance and crack propagation resistance are high
- The inner surfaces of PE Pipes are smooth, providing an advantage in diameter selection.
- Provides ease of assembly due to its easy flexibility advantage.
- It operates smoothly at nominal operating pressure for at least 50 years.
- It is not affected by corrosive substances in the soil and does not require cathodic protection.
- PE Pipes are resistant to UV rays and chemicals.
- PE Pipes do not change the smell and taste of water, therefore suitable for healthy.
- They are suitable for installing on sea bottom, they are not affected from sea water and sea movements.
- There is no assembly waste due to assembly methods. It is not possible for plant and tree roots to penetrate inside the pipes.

HDPE Pipes and LDPE Pipes

HDPE PIPES - PN6 (Darkblue)

CODE	ØD (mm)	Length (m)
7500060020L	20	100
7500060025L	25	100
7500060032L	32	100
7500060040L	40	100
7500060050L	50	100
7500060063L	63	100
7500060075L	75	100
7500060090L	90	100



HDPE PIPES - PN10 (Darkblue)

CODE	ØD (mm)	Length (m)
7500100020L	20	100
7500100025L	25	100
7500100032L	32	100
7500100040L	40	100
7500100050L	50	100
7500100063L	63	100
7500100075L	75	100
7500100090L	90	100



LDPE PIPES - PN6 (Blue-White)

CODE	ØD (mm)	Length (m)
7501060020M	20	100
7501060025M	25	100
7501060032M	32	100
7501060040M	40	100
7501060050M	50	100
7501060063M	63	100
7501060075M	75	100



LDPE PIPES - PN10 (Blue-White)

CODE	ØD (mm)	Length (m)
7501100020M	20	100
7501100025M	25	100
7501100032M	32	100
7501100040M	40	100
7501100050M	50	100
7501100063M	63	100
7501100075M	75	100
7501100090M	90	100



Hoses Systems



Do's and Don'ts in hoses

- Hoses which are in coil shape, should be stored horizontally and properly in order to avoid deformity.
- The temperature should be between 10-30 °C in storage area.
- Hoses that are stored in low temperature areas should be allowed to reach normal environmental temperature before usage. (Low temperature makes hoses stiff).
- Hoses should not be used at higher working temperatures and working pressures that are specified at technical catalogue.
- Hoses should be protected against stroke.



GREEN SUCTION & BLOWING HOSES (Flex)

CODE	WORKING PRESSURE	G"
7322000254Y	6 Bar	1"
7322000318Y	6 Bar	1.1/4"
7322000381Y	6 Bar	1.1/2"
7322000508Y	5 Bar	2"
7322000635Y	5 Bar	2.1/2"
7322000762Y	5 Bar	3"
7322001016Y	5 Bar	4"



YELLOW SUCTION & BLOWING HOSES (Flex)

CODE	WORKING PRESSURE	G"
7323000254S	5 Bar	1"
7323000318S	5 Bar	1.1/4"
7323000381S	5 Bar	1.1/2"
7323000508S	4 Bar	2"
7323000635S	4 Bar	2.1/2"
7323000762S	4 Bar	3"
7323001016S	4 Bar	4"



RED SUCTION & BLOWING HOSES (Flex)

CODE	WORKING PRESSURE	G"
7324000254K	4 Bar	1"
7324000318K	4 Bar	1.1/4"
7324000381K	4 Bar	1.1/2"
7324000508K	4 Bar	2"
7324000635K	4 Bar	2.1/2"
7324000762K	4 Bar	3"
7324001016K	4 Bar	4"

Hoses Systems

TRANSPARENT WATER HOSES (Flex)

CODE	WORKING PRESSURE	G"
7321000191	19 Bar	3/4"
7321000254	25 Bar	1"
7321000290	29 Bar	1.1/7"
7321000318	32 Bar	1.1/4"
7321000381	38 Bar	1.1/2"



DUST AIR HOSES (Flex)

CODE	G"
7325001016	4"



TRANSPARENT HOSES (Super Extra)

CODE	WORKING PRESSURE	G"
7301000127	6 Bar	1/2"
7301000159	6 Bar	5/8"
7301000191	6 Bar	3/4"
7301000254	5 Bar	1"
7301000318	5 Bar	1.1/4"
7301000381	5 Bar	1.1/2"
7301000508	5 Bar	2"



TRANSPARENT HOSES (Milimetric)

CODE	DIAMETERS
7301000040	4 mm
7301000050	5 mm
7301000060	6 mm
7301000080	8 mm
7301000100	10 mm



AUTOMATIVE INDUSTRIAL TRANSPARENT HOSES

CODE	DIAMETERS
7302004008	4 x 8
7302005009	5 x 9
7302006010	6 x 10
7302007012	7 x 12
7302008013	8 x 13
7302009014	9 x 14
7302010016	10 x 16



Hoses Systems



BRAIDED GARDEN HOSES (Meteor)

CODE	WORKING PRESSURE	G"
7420000127	4 Bar	1/2"
7420000159	4 Bar	5/8"
7420000191	4 Bar	3/4"
7420000254	4 Bar	1"



BRAIDED TRANSPARENT HOSES

CODE	WORKING PRESSURE	G"
7351000127	4 Bar	1/2"
7351000159	4 Bar	5/8"
7351000191	4 Bar	3/4"
7351000254	4 Bar	1"
7351000318	4 Bar	1.1/4"



NEW GARDEN HOSES

CODE	WORKING PRESSURE	G"
7354000127	4 Bar	1/2"
7354000159	4 Bar	5/8"
7354000191	4 Bar	3/4"
7354000254	4 Bar	1"
7354000318	4 Bar	1.1/4"



DOUBLE BRAIDED HOSES

CODE	G"
7358000127K	1/2"
7358000127S	1/2"



BRAIDED TRANSPARENT HOSES (Çınar)

CODE	WORKING PRESSURE	G"
7350000127	19	1/2"
7350000159	25	5/8"
7350000191	29	3/4"
7350000254	32	1"
7350000318	38	1.1/4"

Hoses Systems

SOFT HOSES (Eco)

CODE	G"
7408100001	1/2"
7408100002	5/8"
7408100003	3/4"
7408100004	1"
7408100005	1.1/4"



SOFT HOSES (Firat)

CODE	WORKING PRESSURE	G"
7408000001	4 Bar	1/2"
7408000002	4 Bar	5/8"
7408000003	4 Bar	3/4"
7408000004	4 Bar	1"
7408000005	4 Bar	1.1/4"



BRAIDED SOFT HOSES

CODE	WORKING PRESSURE	G"
7408200001	4 Bar	1/2"



TRANSPARENT WATER HOSES (Çınar)

CODE	G"
7321001254	1"
7321001290	1.1/7"
7321001318	1.1/4"



AIR CONDITIONER HOSES

CODE	WORKING PRESSURE	G"
7303050849	2 Bar	5/8"



Hoses Systems



WASHING MACHINE INLET HOSES (Red-Blue)

CODE	WORKING PRESSURE	LENGTH
7400100150	10 Bar	1.5 m
7400100200	10 Bar	2 m
7400100250	10 Bar	2.5 m
7400100300	10 Bar	3 m
7400100400	10 Bar	4 m
7400100500	10 Bar	5 m



WASHING MACHINE OUTLET HOSES

CODE	LENGTH
7409117503	1.5 m
7409117504	2 m
7409117505	2.5 m
7409117506	3 m



GAS HOSES

CODE	DIAMETER
7307080000	8 mm
7307100000	10 mm



BRAIDED GAS HOSES

CODE	DIAMETER
7357000060	6 mm
7357000080	8 mm
7357000100	10 mm

Hoses Systems

THERMORUBBER WATER HOSES (Green-Black / 60 atm)

Black-CODE	Green-CODE	WORKING PRESSURE	G"
7401000127	7401000127Y	6 Bar	1/2"
7401000159	7401000159Y	6 Bar	5/8"
7401000191	7401000191Y	6 Bar	3/4"
7401000254	7401000254Y	6 Bar	1"
7401000318	7401000318Y	6 Bar	1.1/4"



THERMORUBBER OXYGEN HOSES (Red-Blue / 60 atm)

CODE	DIAMETER	WORKING PRESSURE	G"
7402000060	6 mm	20 Bar	1/4"
7402000080	8 mm	20 Bar	5/16"
7402000100	10 mm	20 Bar	3/8"



THERMORUBBER COMPRESSOR HOSES (60 atm)

CODE	WORKING PRESSURE	G"
7404000127	20 Bar	1/2"
7404000159	20 Bar	5/8"
7404000191	20 Bar	3/4"



THERMORUBBER COMPRESSOR HOSES (200 atm)

CODE	WORKING PRESSURE	DIAMETER
7405000100	80 Bar	10 mm
7405000120	50 Bar	12 mm



FIRE HOSES

CODE	WORKING PRESSURE	G"
7406000254	12 Bar	1"
7406020254	12 Bar	1"
7406025254	12 Bar	1"
7406030254	12 Bar	1"
7406040254	12 Bar	1"
7406050254	12 Bar	1"
7406060254	12 Bar	1"



Drainage Pipes

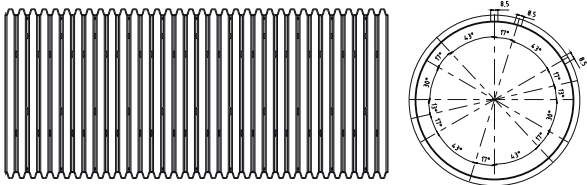
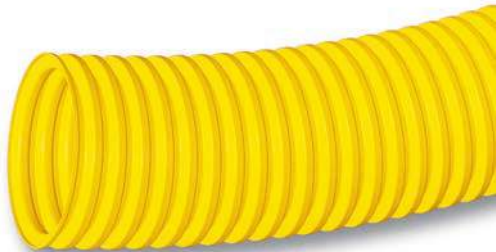
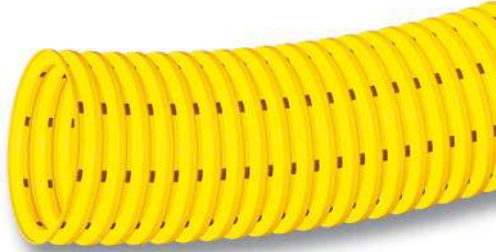

General Qualities

Firat PVC-U Drainage Pipes are produced from raw material of hard PVC-U in accordance to the norms of TS 9128 and DIN 1187, with the size range of 80, 110, 125, 160 and 200 mm. Water entry hole size of PVC-U Drainage Pipes are included in the middle size group ($1,2 \pm 0,2$ mm) as stated in TS 9128 standard. Firat PVC-U Drainage Pipes, which can be used safely even under heavy chemical conditions, has the service life of 50 years.

Area of Use

It works safely in;

- Protection of the buildings and constructions that have water in foundations.
- Shoulder drainages of highways.
- Underconstructions of sports facilities (turf, court, course).
- Rehabilitation works of muddy and loamy lands.
- Removal of unwanted water off of the land in agriculture.

Physical Specifications of Drainage PVC-U Pipes

Diameter (mm)	Outer Diameter* (mm/minimum)	Internal Diameter (mm)	Minimum Coil Reeling Diameter (mm)
80	$80 \pm 0,5$	71.5	600
110	$100 \pm 0,5$	91	700
125	$122.5 \pm 0,5-1$	115	750
160	$155.3 \pm 0,5-1$	144	1000
200	$199.5 \pm 0,5-$	182	1000

DRAINAGE PIPES*

CODE	DIAMETER
712000001	80
712000002	110
712000003	125
712000004	160
712000005	200

* Shipping is covered by the consignee in drainage pipes.

DRAINAGE PIPES*

CODE	DIAMETER
7120000011	80
7120000012	110
7120000013	125
7120000014	160
7120000015	200

* Shipping is covered by the consignee in drainage pipes.

Our Quality Certificates

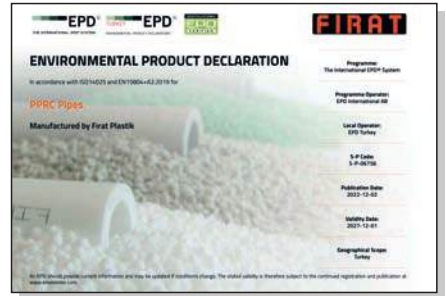

FIRAT sells to a lot of Countries in Europe, America, Asia and Africa

- 
- ABKHAZIA
 - AFGHANISTAN
 - ALBANIA
 - ALGERIA
 - ARGENTINA
 - ARMENIA
 - AZERBAIJAN
 - BAHRAIN
 - BANGLADESH
 - BELARUS
 - BELGIUM
 - BOLIVIA
 - BOSNIA & HERZEGOVINA
 - BRAZIL
 - BULGARIA
 - CAMEROON
 - CANADA
 - CHAD
 - CHINA
 - CHILE
 - COSTA RICA
 - COLOMBIA
 - CROATIA
 - CUBA
 - CZECH REPUBLIC
 - DJIBOUTI
 - ECUADOR
 - EGYPT
 - EL SALVADOR
 - ENGLAND
 - ETHIOPIA
 - FINLAND
 - FRANCE
 - GABON
 - GAMBIA
 - GERMANY
 - GEORGIA
 - GHANA
 - GREECE
 - GUATEMALA
 - HONDURAS
 - HUNGARY
 - ICELAND
 - INDIA
 - ITALY
 - IRAN
 - IRAQ
 - IVOR COAST
 - JORDAN
 - KAZAKHSTAN
 - KENYA
 - KOSOVO
 - KUWAIT
 - KYRGYZSTAN
 - LATVIA
 - LEBANON
 - LIBYA
 - LITHUANIA
 - MACEDONIA
 - MALTA
 - MALI
 - MAURITANIA
 - MAURITIUS
 - MEXICO
 - MOLDOVA
 - MONGOLIA
 - MONTENEGRO
 - MOROCCO
 - MOZAMBIQUE
 - NETHERLANDS
 - NEW ZEALAND
 - NIGERIA
 - NIGER
 - OMAN
 - PAKISTAN
 - PANAMA
 - PARAGUAY
 - PERU
 - POLAND
 - PORTUGAL
 - ROMANIA
 - RUSSIA
 - SAUDI ARABIA
 - SERBIA
 - SENEGAL
 - SINGAPORE
 - SLOVAKIA
 - SLOVENIA
 - SOMALI
 - SOUTH AFRICA
 - SPAIN
 - SRI LANKA
 - SUDAN
 - SURINAME
 - SYRIA
 - SWEDEN
 - TAJIKISTAN
 - TANZANIA
 - TOGO
 - TUNISIA
 - TURKISH REPUBLIC OF NORTHERN CYPRUS
 - TURKMENISTAN
 - UGANDA
 - UKRAINE
 - UNITED ARAB EMIRATES
 - UNION OF THE COMOROS
 - UNITED STATES OF AMERICA
 - URUGUAY
 - UZBEKISTAN
 - VENEZUELA
 - QATAR
 - YEMEN
 - ZANZIBAR

FIRAT

Türkoba Mahallesi

Firat Plastik Caddesi No:23

34537 Büyükçekmece İstanbul / TURKEY

T: +90 (212) 866 41 41 - 866 42 42

F: +90 (212) 859 04 00 - 859 05 00

 /firatplastik

 /firatplastik

 /firatplastik

 /firatplastik

www.firat.com

export@firat.com

info@firat.com